

ASSEMBLY INSTRUCTION

EASTERN KING HEADBOARD

- A** Upper Part of Headboard **B** Middle Part of Headboard **C** Lower Part of Headboard **D** Left Side Panel **E** Right Side Panel

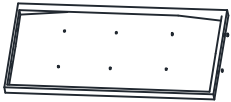

1pc

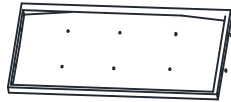

1pc

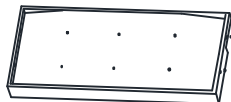

1pc

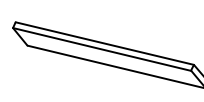

1pc

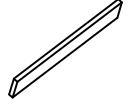

1pc

- F** Single-Sided Cover (In other carton) **G** Slate **H** Bolt 1/4" x 50mm **I** Flat Washer 1/4" **J** Lock Washer 1/4"



1pc

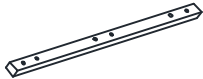

3pcs



30pcs



30pcs



30pcs

- K** Allen Wrench 1/4"



1pc

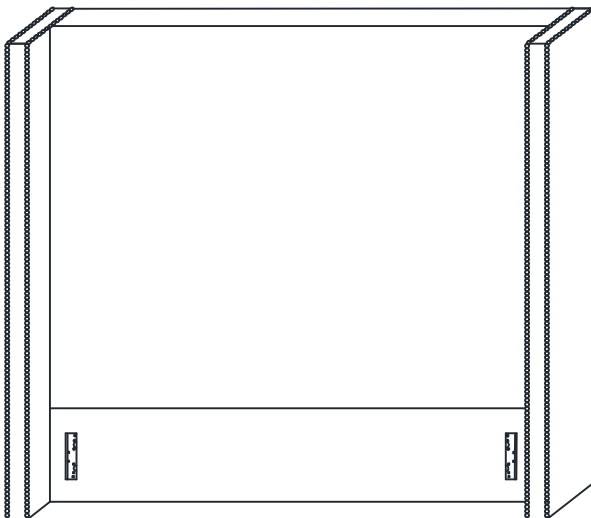

This page lists all the contents included in the box. Please take the time to identify the hardware as well as the individual components to this product. As you unpack and prepare for assembly, place the contents on a carpeted or padded area to protect them from damage.

Notice: This product need more than 2 people to assemble it.

1

Attach Upper Part of Headboard (A) & Middle Part of Headboard (B) & Lower Part of Headboard (C) together with Bolt (H), Lock Washer (J) and Flat Washer (I) on holes of Slates (G). Turn the Allen Wrench (K) in Bolt (H).

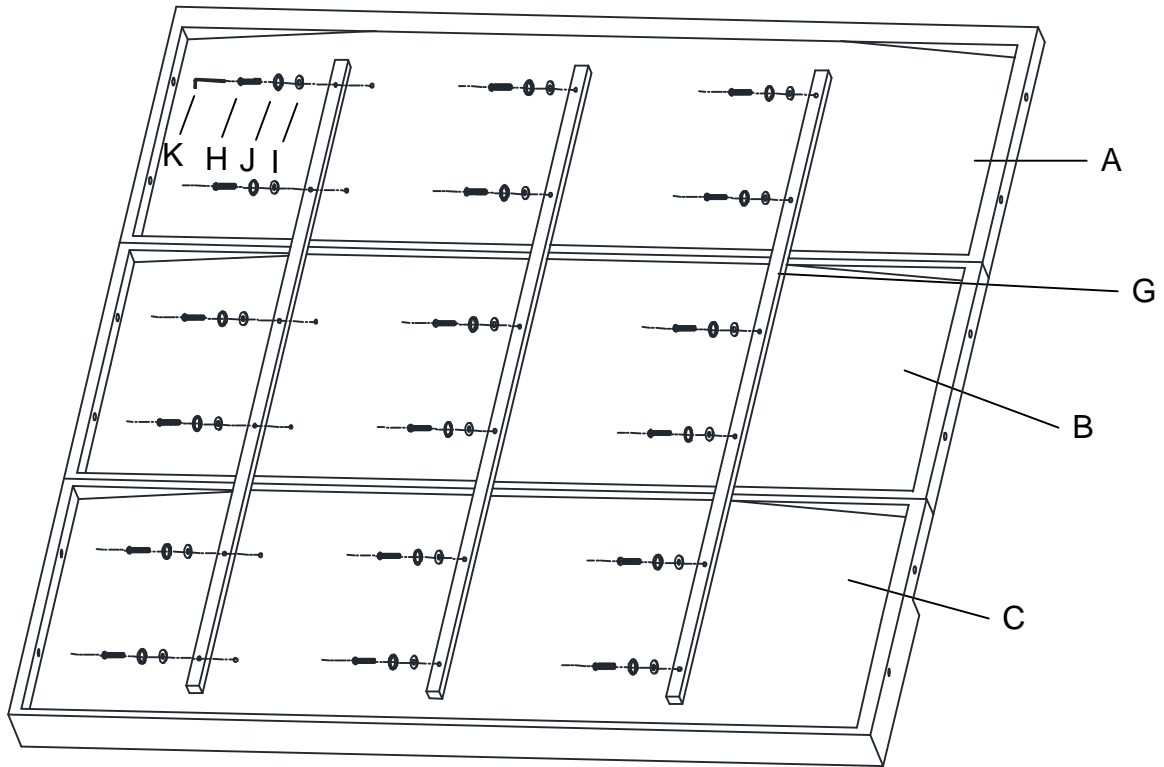
**2**

Put Single-Sided Cover (F) on the front of Headboard (A) & (B) & (C). Then stick the velcro at the back of Headboard (A) & (B) & (C).

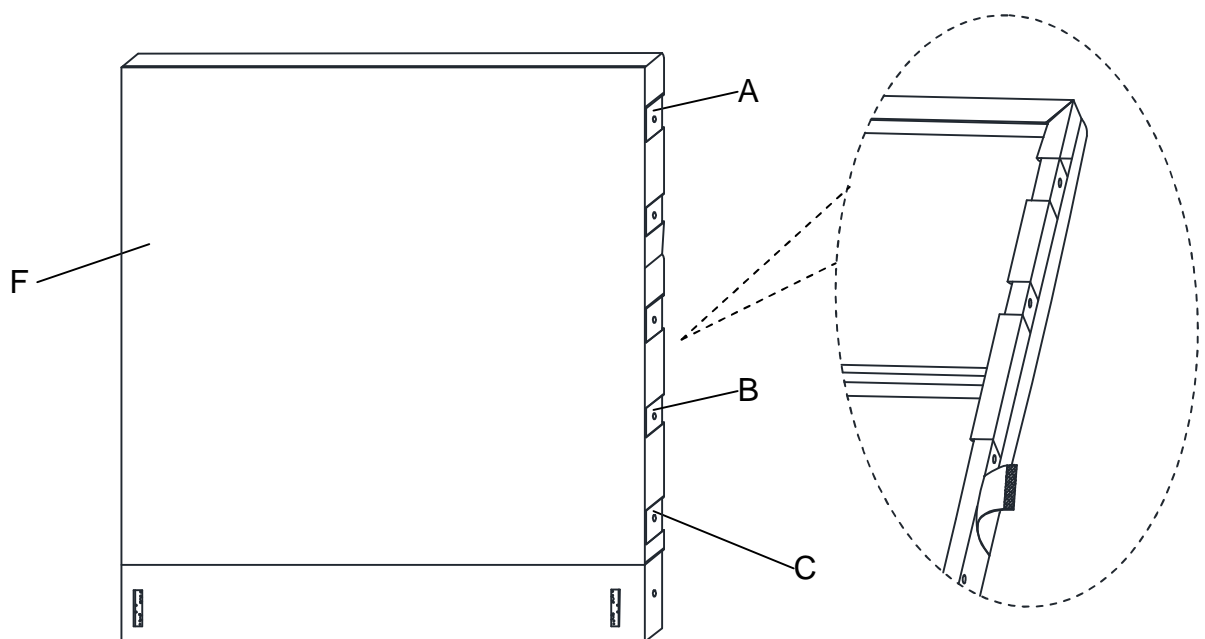

3

Attach Left Side Panel (D) & Right Side Panel (E) to the Headboard (A) & (B) & (C) with Bolt (H), Lock Washer (J) and Flat Washer (I). Turn the Allen Wrench (K) in Bolt (H).

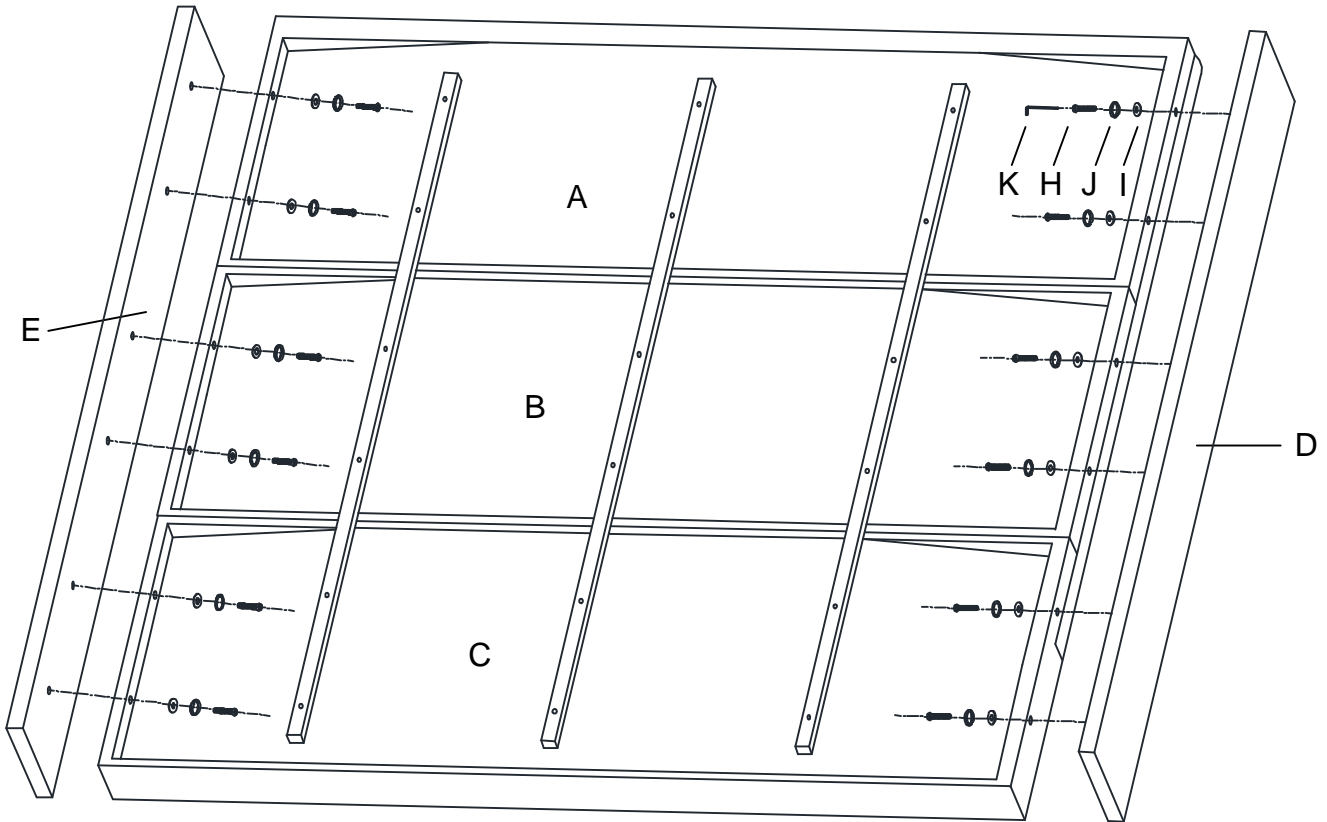

Helpful Tip:











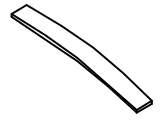

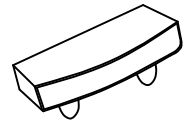
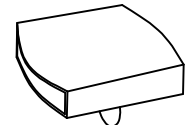
- After assembly, if fabric is not smooth or wrinkled, please iron it.

Cleaning & Care

Treat surface with care. Surface is resistant to scratches but is not scratch resistant. Clean surfaces with a dry or damp soft cloth. Do not use abrasive cleaners. Hardware may loosen over time. Periodically check that all connections are tight.

ASSEMBLY INSTRUCTION

KING BED - EURO SLATS PARTS

A Wooden Slat	B Support Leg	C Iron Pipe	D Single-Sided Cover	E Double-Sided Cover
				
39pcs	8pcs	2pcs	26pcs	26pcs
F Flat Washer	G Lock Washer	H Bolt 1/4" x 30mm	I Bolt 1/4" x 50mm	J Allen Wrench
				
28pcs	24pcs	4pcs	16pcs	1pc
K Iron Pipe	L Bolt 1/4" x 65mm	M Nut	N Wrench	O Iron Pipe
				
1pc	4pcs	4pcs	1pc	2pcs

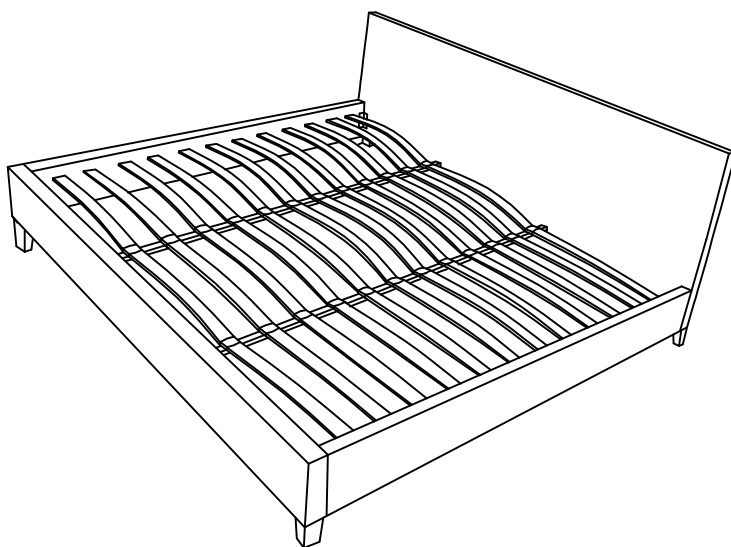

This page lists all the contents included in the box. Please take the time to identify the hardware as well as the individual components to this product. As you unpack and prepare for assembly, place the contents on a carpeted or padded area to protect them from damage

1

Attached Iron Pipe(O) to the both Side Rails use Bolt(I), Flat Washer(F), Lock Washer(G) by Allen Wrench(J).

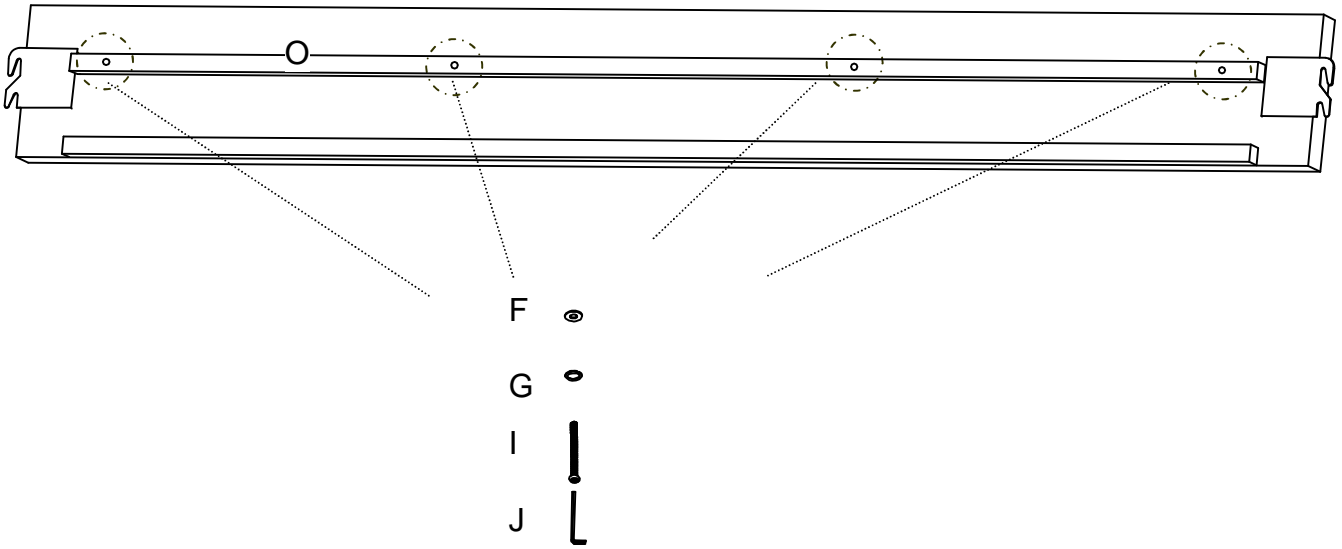

2

Attached Support Leg(B) to the Iron Pipe(C) use Bolt(I), Flat Washer(F), Lock Washer(G) by Allen Wrench(J). Then assembly Iron Pipe(C) to Footboard use Bolt(H), Flat Washer(F), Lock Washer(G) by Allen Wrench(J).

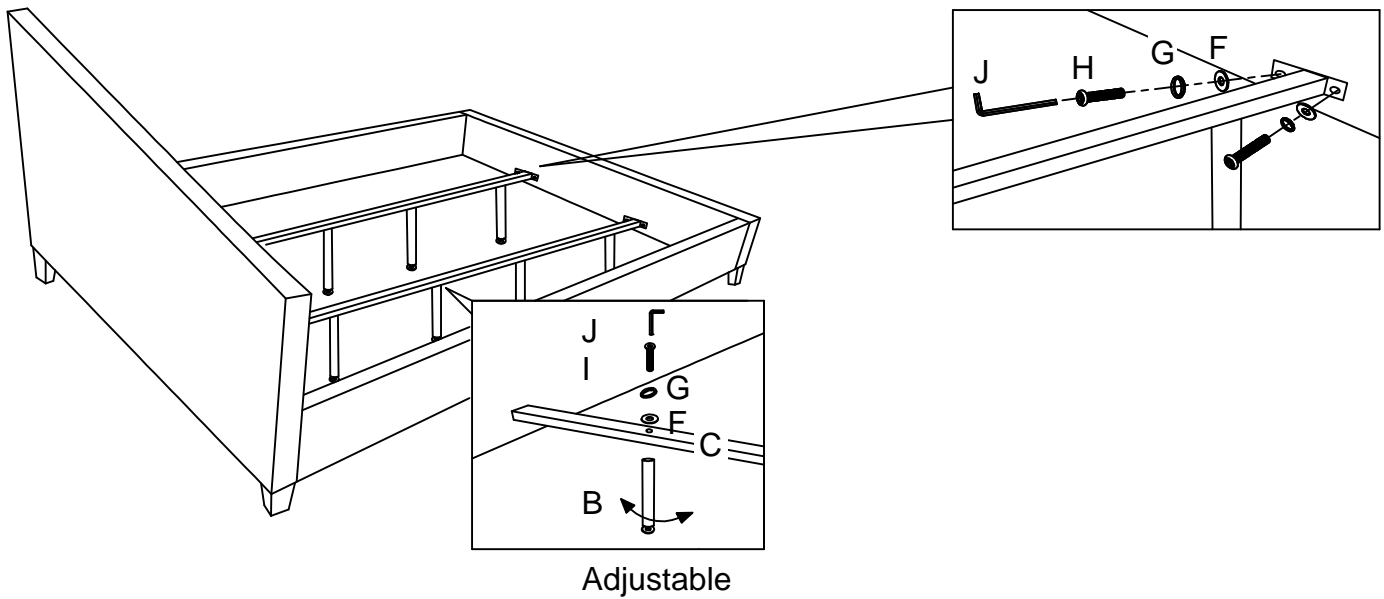

3

Assembly Iron Pipe(K) to Iron Pipe(O) and Iron Pipe(C) with Bolt(L), Flat Washer(F), Lock Washer(G), Nut(M) by Allen Wrench(J) & Wrench(N).

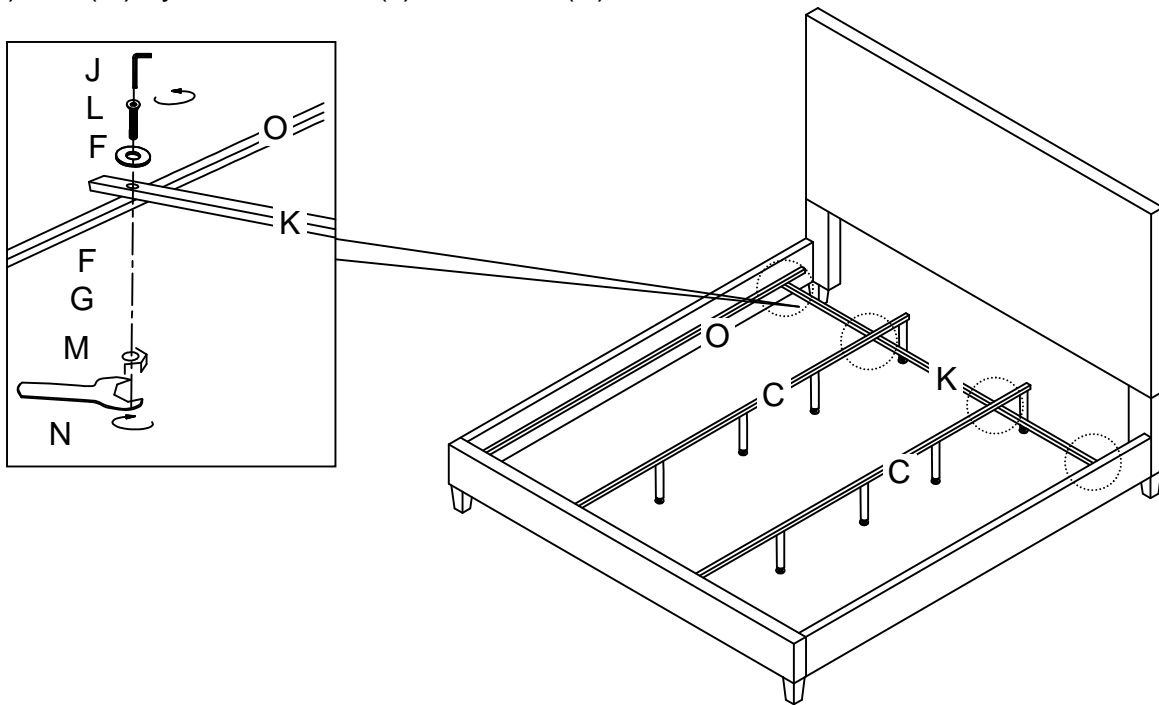
**4**

Attach Wooden Slat(A) with Single-Sided Cover(D) at both end, then attach the Wooden Slat(A) into Double-Sided Cover(E) and press downward Double-Sided Cover(E) lock in the hole on the center metal rail.

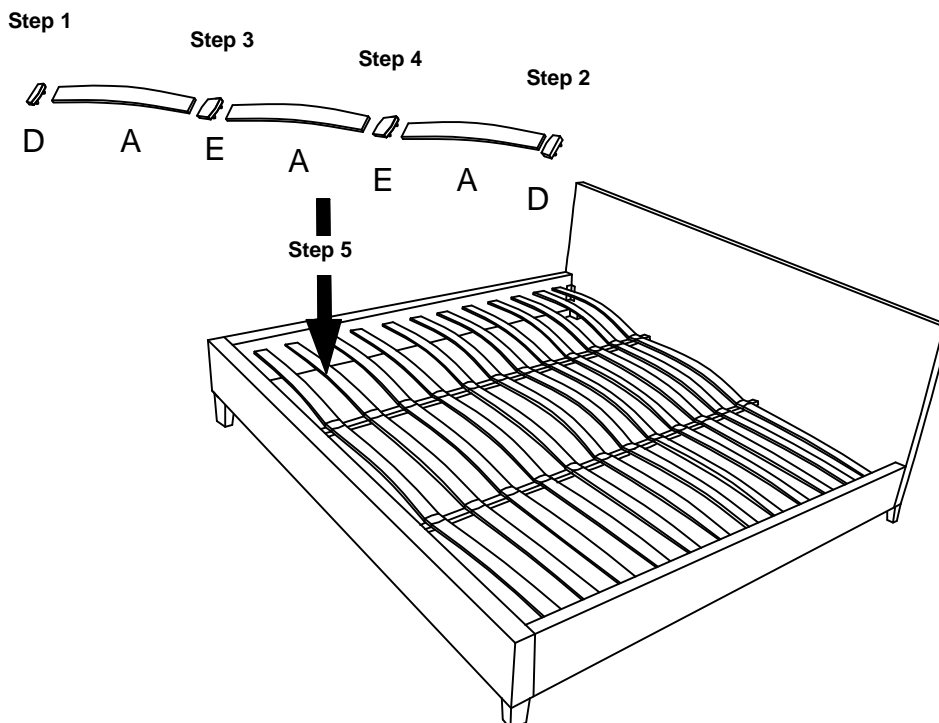

Cleaning & Care

Treat surface with care. Surface is resistant to scratches but is not scratch resistant. Clean surfaces with a dry or damp soft cloth. Do not use abrasive cleaners. Hardware may loosen over time. Periodically check that all connections are tight