

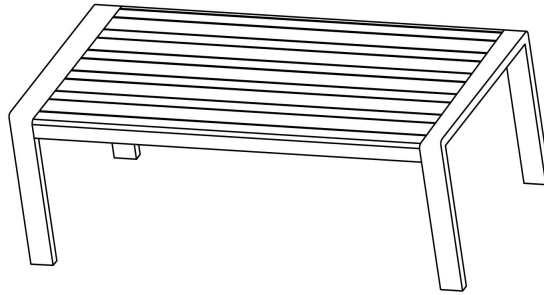

Assembly Instructions

Caution: You must read this before you proceed



TABLE

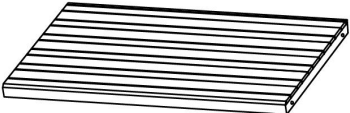

Parts List

Label	Picture	Description	QTY
A		Table Top	1
B		Leg	2

Hardware

Label	Picture	Description	QTY
①		Bolt (M6*35MM)	5
②		Allen Key	1

Assembly Preparation

Before Beginning Assembly:

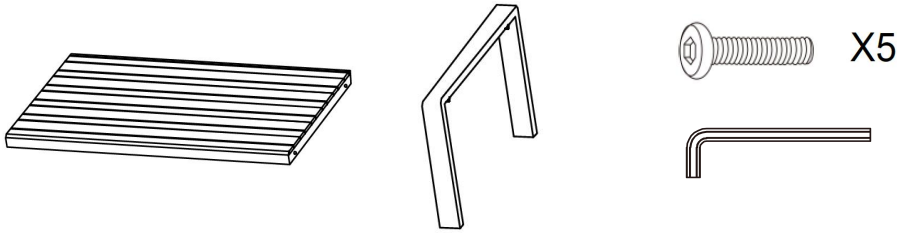

- Read instructions, cover to cover-



- Have 2 adults on hand for assembly-



- Do not assemble on flooring or carpet-



- Assemble on a clean non-marring surface (packing foam)-



- Save all packaging until finished-

Assembly Steps

Overview

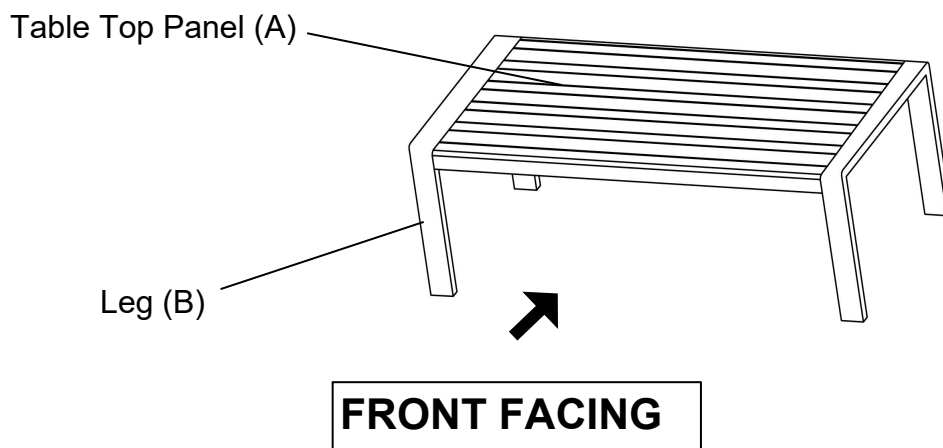

This Table has multiple parts and may require up to 30 minutes to assemble. To give you an overview of the Table parts, the above picture is to help you put the various parts into perspective. Please read through the instructions below to familiarise yourself with the parts and steps before assembly.

Step 1

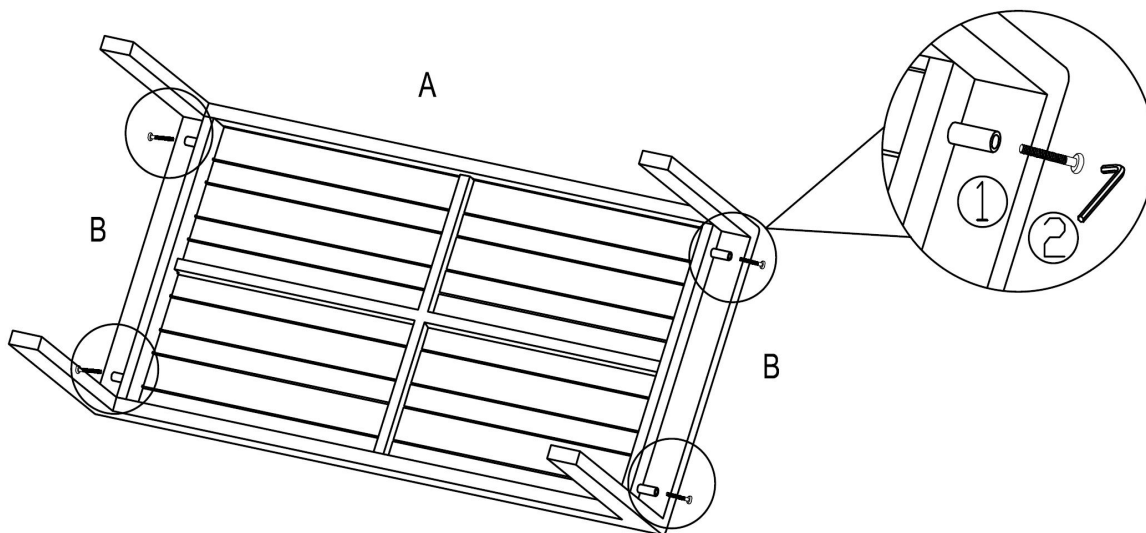





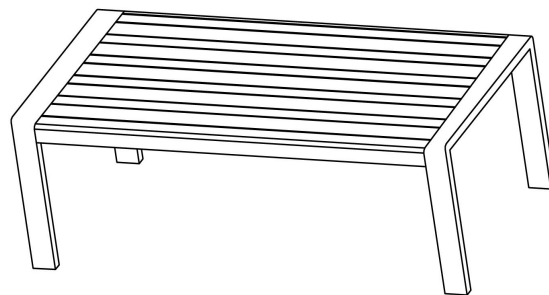















Place the Table Top(A) facedown on a clean non-marring surface.
Attach one of the Legs(B) to the Table Top(A) using Bolts(1) and the Allen Key(2) as shown above.
Repeat the same process to install the remaining Leg(B).
Do not fully tighten the Bolts.

Step 2



Place the Table on a **LEVEL SURFACE** to check for wobbles.
If it wobbles, apply even steady pressure downwards on the Table.
This action should help align all parts.
Then proceed to tighten all Bolts at all joints
Do **NOT** fully tighten a Bolt in one go and then move on to the next one.
Rather, in a sequential manner, gradually tighten each Bolt until all Bolts are evenly secured.
This methodology will ensure maximum evenness once all Bolts are fully tightened.
Your Table is ready for use.
This Table can only be used on a flat, level surface.

Care & Maintenance

-   ● Do not put hot items directly on furniture surface
 -   ● Do not clean furniture with harsh cleansers or polish.
 -   ● To obtain the longest lifespan of your outdoor products, minimizing exposure to direct sunlight is recommended.
 -   ● Children should not climb or jump on the furniture.
 -   ● Do not write on furniture without a padded barrier to protect the surface.
 -   ● To obtain the longest lifespan of your outdoor products, avoid extended and lengthy exposure to rain, snow, and direct sunshine. Whenever possible cover the product and /or place under patio or awnings.
 -   ● Not for commercial use. For residential use only .
 -   ● Stains may be removed with mild soap solution and damp cloth.
 -   ● Keep away from sources of ignition.
-
-   ● Dust and pick-up spills using a clean, non-colored, lint-free cloth.