



ELECTRIC COOKTOP

COS-244ECC

COS-304ECC

COS-365ECC

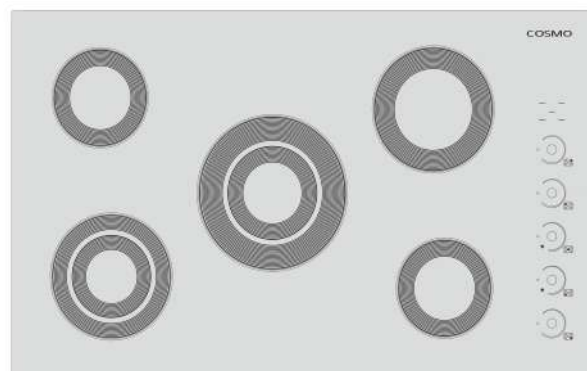
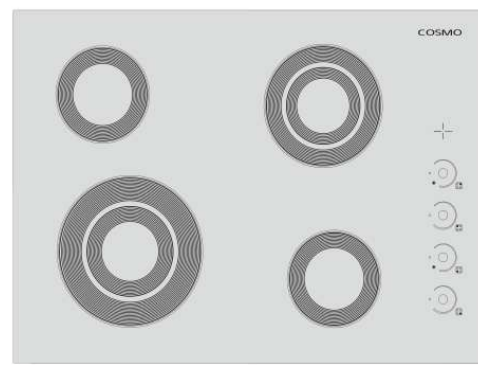
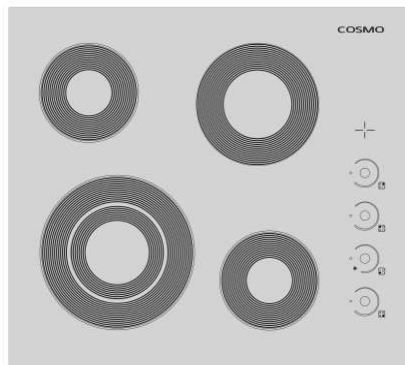

User Manual

IMPORTANT SAFETY INSTRUCTIONS: Carefully read the following important information regarding installation safety and maintenance. Keep these instructions for future reference.

THANK YOU FOR YOUR PURCHASE

Thank you for your purchase! We know that you have many brands and products to choose from and we are honored to know that you have decided to take one of our products into your home and hope that you enjoy it.

COSMO appliances are designed according to the strictest safety and performance standards for the North American market. We follow the most advanced manufacturing philosophy. Each appliance leaves the factory after thorough quality inspection and testing. Our distributors and our service partners are ready to answer any questions you may have regarding how to install, use and care for your products. We hope that this manual will help you learn to use the product in the safest and most effective manner.

If you have any questions or concerns, please contact the dealer from whom you purchased it, or contact our Customer Support Team at **1-888-784-3108**, or visit **cosmoappliances.com**.

Please read the important safety instructions before using the appliance for your own safety, and to reduce the risk of hazards such as injury, fire and electrical shock.

Please keep this manual for future use.

Once again, thank you!



APPLIANCES

TABLE OF CONTENTS

SAFETY & WARNINGS	4-5
OPERATING INSTRUCTIONS	6-11
Cooktop Controls	6-7
Dual Zone Element	8
Ceramic Glass Cooktop Surface	9
Cookware	10
Home Canning	11
CARE & MAINTENANCE	12
General Cleaning	12
Ceramic Glass Cleaning	12
Cooktop Knob Cleaning	12
PRODUCT DIAGRAMS	13-15
COS-244ECC	13
COS-304ECC	14
COS-365ECC	15
TROUBLESHOOTING	16
WARRANTY & SERVICE	17-18

SAFETY & WARNINGS

SAVE THESE INSTRUCTIONS FOR FUTURE REFERENCE.



This is the safety alert symbol.

This symbol alerts you to potential hazards that can kill or hurt you and others.

All safety messages follow the safety alert symbol and one of the following words:

- ▲ **DANGER!**: You can be killed or seriously injured if you do not immediately follow instructions.
- ▲ **WARNING!**: You can be killed or seriously injured if you don't follow instructions.
- ▲ **CAUTION!**: Hazards or unsafe practices COULD result in minor personal injury if you don't follow instructions.

Always read and obey all safety messages.

▲ **WARNING!**: To reduce the risk of fire, electrical shock, injury to persons, or damage when using the cooktop, follow basic precautions, including the following safety and warnings.

▲ **CAUTION!**: **DO NOT** store items in cabinets above the cooktop that is of interest to children. Children climbing on the cooktop to reach items could be seriously injured.

THIS PRODUCT IS INTENDED FOR HOUSEHOLD USE ONLY.

- Be sure your cooktop is properly installed and grounded by a qualified technician.
- **DO NOT** repair or replace any part of the cooktop unless specifically recommended in the manual. All other servicing **SHOULD** be referred to a qualified technician.
- Wear proper apparel. Loose-fitting or hanging garments **SHOULD NEVER** be worn while using the cooktop.
- **DO NOT** store flammable materials near cooktop or surface burners.
- Only certain types of glass, glass/ceramic, ceramic, earthenware, or other glazed utensils are suitable for cooktop service without breaking due to the sudden change in temperature.
- Utensil handles **SHOULD** be turned inward and not extend over adjacent surface units. To reduce the risk of burns, ignition of flammable materials and spillage due to unintentional contact with the utensil, the handle of a utensil **SHOULD** be positioned so that it is turned inward, and does not extend over adjacent surface units.
- **DO NOT** use water on grease fires. Smother fire or flame or use dry chemical or foam-type extinguisher.
- **NEVER leave surface units unattended at high heat settings.** Boilover causes smoking and greasy spillovers that may ignite.
- **Children SHOULD NOT be left alone or unattended in the area where the cooktop is in use.** They **SHOULD NEVER** be allowed to sit or stand on any part of the cooktop.

SAFETY & WARNINGS

- **DO NOT** touch surface units or areas near units. Surface units may be hot even though they are dark in color. Areas near surface units may become hot enough to cause burns.
- During and after use, **DO NOT** touch, or let clothing or other flammable materials contact surface units or areas near units until they have had sufficient time to cool. Among those areas are the cooktop and surfaces facing the cooktop.
- **Use proper pan size.** This cooktop is equipped with one or more surface units of different sizes. Select cookware has flat bottoms large enough to cover the surface unit heating element. The use of undersized cookware will expose a portion of the heating element to direct contact and may result in the ignition of clothing. Proper sizing of cookware to burners will also improve efficiency.
- Use only dry potholders. Moist or damp potholders on hot surfaces may result in burns from steam. **DO NOT** let potholder touch hot heating elements. **DO NOT** use a towel or other bulky cloth.
- **DO NOT COOK ON A BROKEN COOKTOP.** If the cooktop should break, cleaning solutions and spillovers may penetrate the broken cooktop and create a risk of electric shock. Contact a qualified technician immediately.
- **NEVER** use your cooktop for warming or heating the room.
- Clean cooktop with caution. If a wet sponge or cloth is used to wipe spills on a hot cooking area, be careful to avoid steam burn.
- Some cleaners can produce noxious fumes if applied to a hot surface.
- Extreme caution **SHOULD** be exercised when using cookware or bakeware constructed of anything other than ovenproof metal or glass.
- **DO NOT** place any of the following materials in the oven: cardboard, plastic, paper, or anything similar.

OPERATING INSTRUCTIONS

COOKTOP CONTROLS

This user manual covers different models. The cooktop you have purchased may have some or all of the items listed. The locations and appearances of the features shown here may not match those of your model.

24 IN. / COS-244ECC

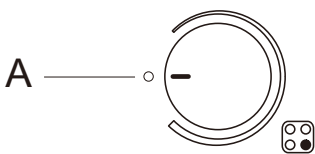
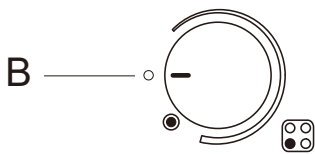
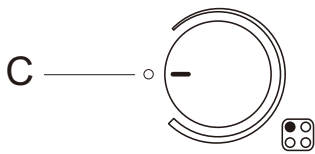
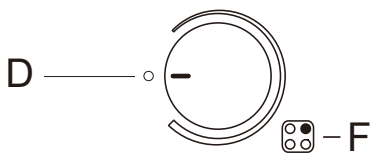
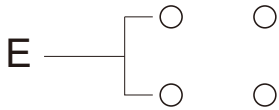

30 IN. / COS-304ECC

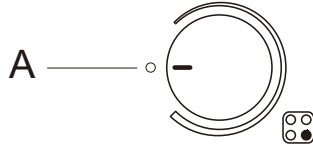
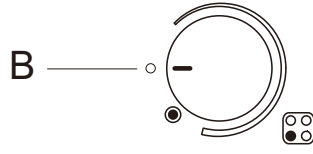
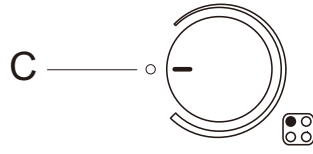
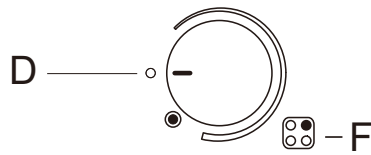
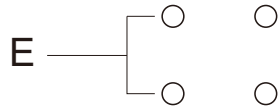

36 IN. / COS-365ECC

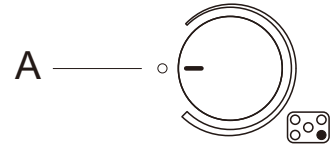
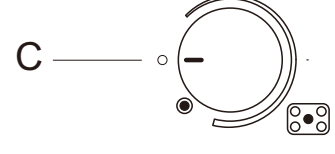
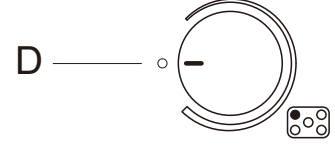
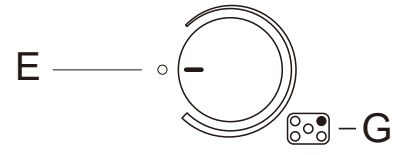
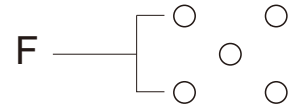

- A.) Right Front Control Knob
- B.) Left Front Control Knob
- C.) Left Rear Control Knob
- D.) Right Rear Control Knob
- E.) Hot Surface Indicator Light
- F.) Surface Cooking Area Locator

- A.) Right Front Control Knob
- B.) Left Front Control Knob
- C.) Left Rear Control Knob
- D.) Right Rear Control Knob
- E.) Hot Surface Indicator Light
- F.) Surface Cooking Area Locator

- A.) Right Front Control Knob
- B.) Left Front Control Knob
- C.) Middle Control Knob
- D.) Left Rear Control Knob
- E.) Right Rear Control Knob
- F.) Hot Surface Indicator Light
- G.) Surface Cooking Area Locator

OPERATING INSTRUCTIONS

COOKTOP CONTROLS



WARNING!: FIRE HAZARD. Turn OFF all controls when not cooking. Failure to do so can result in fire, injury or death.

Cooktop Control Knob

The control knobs can be set to anywhere between LOW and HIGH. Push in and turn the control knob to set the desired heat level.

Surface Cooking Area Locator

The surface cooking area locator shows which burner element is turned on.

Use the following chart as a guide when setting heat levels.

▲ WARNING!: When cooktop is in use, the entire cooktop area may become hot.

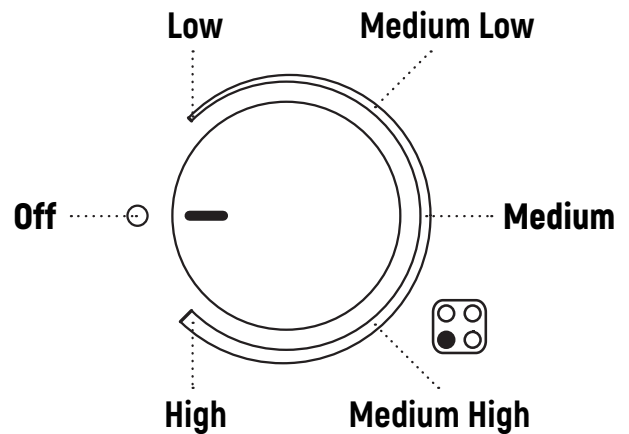

SETTING	RECOMMENDED USE
High	<ul style="list-style-type: none"> Start cooking food. Bring liquid to a boil.
Medium High	<ul style="list-style-type: none"> Hold a rapid boil. Quickly brown or sear food.
Medium	<ul style="list-style-type: none"> Maintain a slow boil. Fry or saute foods. Cook soups, sauces and gravies. High simmer or simmer without lids.
Medium Low	<ul style="list-style-type: none"> Stew or steam food. Simmer.
Low	<ul style="list-style-type: none"> Keep food warm. Melt chocolate or butter. Low simmer using lids.
Dual Elements	<ul style="list-style-type: none"> Home canning. Large-diameter cookware. Large quantities of food.

OPERATING INSTRUCTIONS

DUAL ZONE ELEMENT

The Dual Zone elements offer flexibility depending on the size of the cookware. A Single Zone element can be used in the same way as a regular element. The Dual Zone element combines single and dual elements and is recommended for larger cookware, large quantities of food, and home canning. The Dual Zone element must have Dual Mode activated before it can be used.

To use the Single Zone element:

- 1.) Push in and turn Control Knob from the OFF ○ position to anywhere between LO and HI ● to adjust cooking temperature.
- 2.) Turn knob to OFF ○ when finished.

To activate DUAL MODE for the Dual Zone element:

- 1.) Push in and turn the Control Knob clockwise from the OFF ○ position, past HI / DUAL MODE ● position, towards the ○ symbol (See Knob Diagram).
- 2.) The Control Knob will click then retract back to the HI / DUAL MODE ● position; Dual Mode is now activated.
- 3.) Use the Control Knob to anywhere between LO and HI ● to adjust cooking temperature.
- 4.) To deactivate Dual Mode, turn the Control Knob to the OFF ○ position. You may then restart the burner to use the Single Zone element.

For best High heat performance, match the burner to cookware size.

For best Low heat or Simmer performance, match cookware to the largest cooking area ring and use a single ring for desired performance.

HOT SURFACE INDICATOR LIGHT

This unit features a Hot Surface Indicator Light. The Hot Surface Indicator Light will glow as long as any surface cooking area is too hot to touch, even after the surface cooking area(s) is turned off.

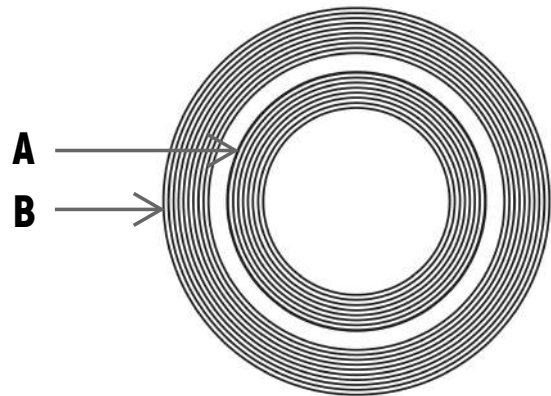

A.) SINGLE ZONE element

B.) DUAL ZONE element

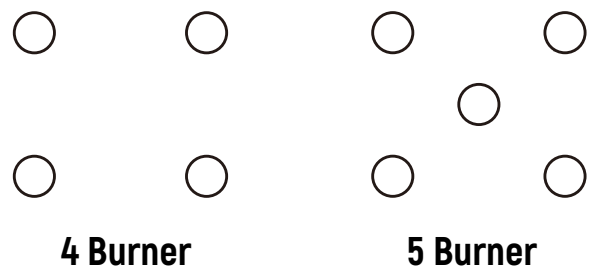
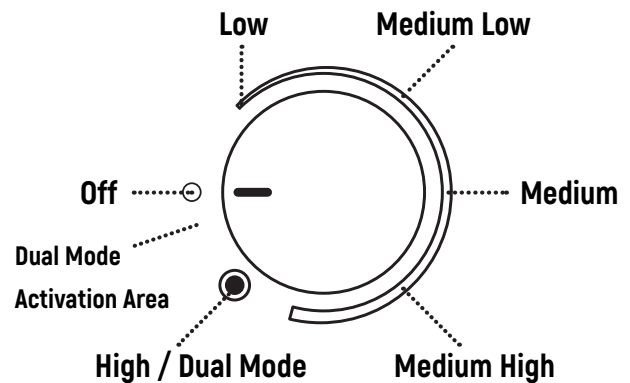

4 Burner

5 Burner

OPERATING INSTRUCTIONS

CERAMIC GLASS COOKTOP SURFACE

The surface cooking area will glow red when an element is on. Some parts of the surface cooking area may not glow red when an element is on; this is normal. The burner will cycle on and off to maintain the selected heat level. It will also randomly cycle off and back on again, even while on High, to keep the cooktop from extreme temperatures. It is normal for the surface of the light-colored ceramic glass to appear to change color when surface cooking areas are hot. As the glass cools, it will return to its original color.

Cleaning off the cooktop before and after each use will help keep it free from stains and provide the evenest heating. On cooktops with light-colored ceramic glass, soils and stains may be more visible and may require more cleaning and attention. A cooktop cleaner and a cooktop scraper are recommended. For more information, see "Care & Maintenance", **Page 12**.

- Avoid storing jars or cans above the cooktop. Dropping a heavy or hard object onto the cooktop could crack the cooktop.
- To avoid damage to the cooktop, do not leave a hot lid on the cooktop. As the cooktop cools, air can become trapped between the lid and the cooktop, and the ceramic glass could break when the lid is removed.
- For foods containing sugar in any form, clean up all spills and soils as soon as possible. Allow the cooktop to cool down slightly. Then, while wearing oven mitts, remove the spills using a scraper while the surface is still warm. If sugary spills are allowed to cool down, they can adhere to the cooktop and can cause pitting and permanent marks.
- To avoid scratches, do not slide cookware or bakeware across the cooktop. Aluminum or copper bottoms and rough finishes on cookware or bakeware could leave scratches or marks on the cooktop.
- Do not cook popcorn in prepackaged aluminum containers on the cooktop. It could leave aluminum marks that cannot be removed completely.
- To avoid damage to the cooktop, do not allow objects that could melt, such as plastic or aluminum foil, to touch any part of the entire cooktop.
- To avoid damage to the cooktop, do not use the cooktop as a cutting board.
- To avoid damage to the cooktop, do not cook foods directly on the cooktop.
- Use flat-bottomed cookware for best heat conduction and energy efficiency. Cookware with rounded, warped, ribbed, or dented bottoms could cause uneven heating and poor cooking results. Determine flatness by placing the straight edge of a ruler across the bottom of the cookware. While you rotate the ruler, no space or light should be visible between it and the cookware.
- Cookware designed with slightly indented bottoms or small expansion channels can be used.
- Make sure the bottoms of pots and pans are clean and dry before using them. Residue and water can leave deposits when heated.

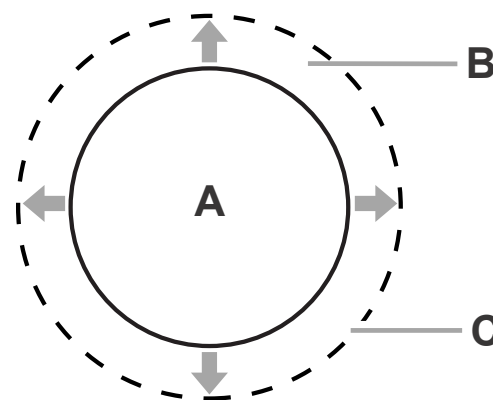

- A.) Surface cooking area
- B.) Cookware/canner
- C.) 1/2" (1.3 cm) maximum overhang

OPERATING INSTRUCTIONS

COOKWARE

▲ CAUTION! Do not leave empty cookware on a hot surface cooking area, element or surface burner.

- Ideal cookware should have a flat bottom, straight sides, and a well-fitting lid and the material should be of medium-to-heavy thickness.
- Rough finishes may scratch the cooktop. Aluminum and copper may be used as a core or base in cookware. However, when used as a base they can leave permanent marks on the cooktop or grates.
- Cookware material is a factor in how quickly and evenly heat is transferred, which affects cooking results. A nonstick finish has the same characteristics as its base material. For example, aluminum cookware with a nonstick finish will take on the properties of aluminum.

Use the following chart as a guide for cookware material characteristics:

COOKWARE	CHARACTERISTICS
Aluminum	<ul style="list-style-type: none"> • Heats quickly and evenly. • Suitable for all types of cooking. • Medium or heavy thickness is best for most cooking tasks.
Cast Iron	<ul style="list-style-type: none"> • Heats slowly and evenly. • Good for browning and frying. • Maintains heat for slow cooking.
Ceramic or Ceramic Glass	<ul style="list-style-type: none"> • Follow cookware manufacturer's instructions. • Heats slowly, but unevenly. • Ideal results on low to medium heat settings.
Copper	<ul style="list-style-type: none"> • Heats very quickly and evenly.
Earthenware	<ul style="list-style-type: none"> • Follow cookware manufacturer's instructions. • Use on low heat settings.
Porcelain enamel-on-steel or cast iron	<ul style="list-style-type: none"> • See stainless steel or cast iron.
Dual Elements	<ul style="list-style-type: none"> • Heats quickly, but unevenly. • A core or base of aluminum or copper on stainless steel provides even heating.

OPERATING INSTRUCTIONS

HOME CANNING

When canning for long periods, alternate the use of surface cooking areas, elements, or surface burners between batches. This allows time for the most recently used areas to cool.

- Center the canner on the grate or largest surface cooking area or element. On electric cooktops, canners should not extend more than ½" (1.3 cm) beyond the surface cooking area or element.
- Do not place canner on 2 surface cooking areas, elements, or surface burners at the same time.
- On ceramic glass models, use only flat-bottomed canners.

For more information on home canning, contact your local agricultural department; companies that manufacture home canning products can also offer assistance.

CARE & MAINTENANCE

▲ IMPORTANT!: Before cleaning, make sure all controls are off and the oven and cooktop are cool. Always follow label instructions on cleaning products.

General Cleaning

Soap, water and a soft cloth or sponge are suggested first unless otherwise noted.

Ceramic Glass Cleaning

Always wipe with a clean, wet cloth or sponge and dry thoroughly to avoid streaking and staining. To avoid damage to the cooktop, do not use steel wool, abrasive powder cleansers, chlorine bleach, rust remover or ammonia.

- **Light to moderate soil:** Paper towels or clean damp sponge.
- **Sugary spills (jellies, candy, syrup)**
 - Cooktop Scraper: Clean while the cooktop is still warm. Wear heat-resistant oven mitts while doing so.
 - Cooktop Polishing Creme and clean damp paper towel: Clean as soon as cooktop has cooled down. Rub creme into surface with a damp paper towel or soft cloth. Continue rubbing until white film disappears.
- **Heavy soil, dark streaks, specks and discoloration:** Use Cooktop Polishing Creme or nonabrasive cleanser; rub product into soil with a damp paper towel or soft cloth. Continue rubbing until white film disappears.
- **Burned-on soil:** Use Cooktop Polishing Creme and Cooktop Scraper; rub creme into soil with damp paper towel. Hold scraper as flat as possible on surface and scrape. Repeat for stubborn spots. Polish entire cooktop with creme and paper towel.
- **Metal marks from aluminum and copper:** Use Cooktop Polishing Creme; clean as soon as cooktop has cooled down. Rub creme into surface with a damp paper towel or soft cloth. Continue rubbing until white film disappears. The marks will not totally disappear but after many cleanings become less noticeable.
- **Tiny scratches and abrasions:** Use Cooktop Polishing Creme; rub creme into surface with a damp paper towel or soft cloth. Continue rubbing until white film disappears. Scratches and abrasions do not affect cooking performance and after many cleanings become less noticeable.

Cooktop Knob Cleaning

When replacing knobs, make sure knobs are in the OFF position. On some models, do not remove seals under knobs. To avoid damage to the cooktop controls, do not use steel wool, abrasive cleansers or oven cleaner, and do not soak knobs.

- **Soap and water**
Pull knobs straight away from control panel to remove.
- **Dishwasher**
Pull knobs straight away from control panel to remove.

PRODUCT DIAGRAM: COS-244ECC

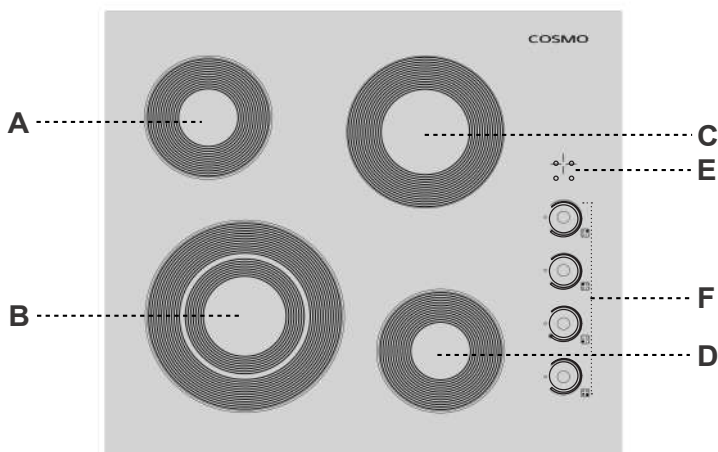
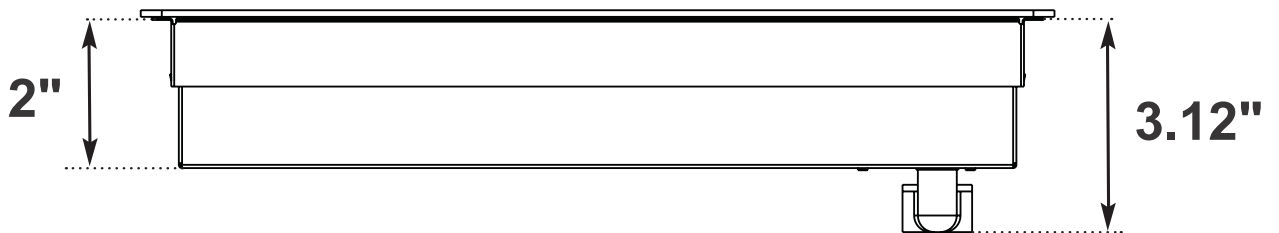
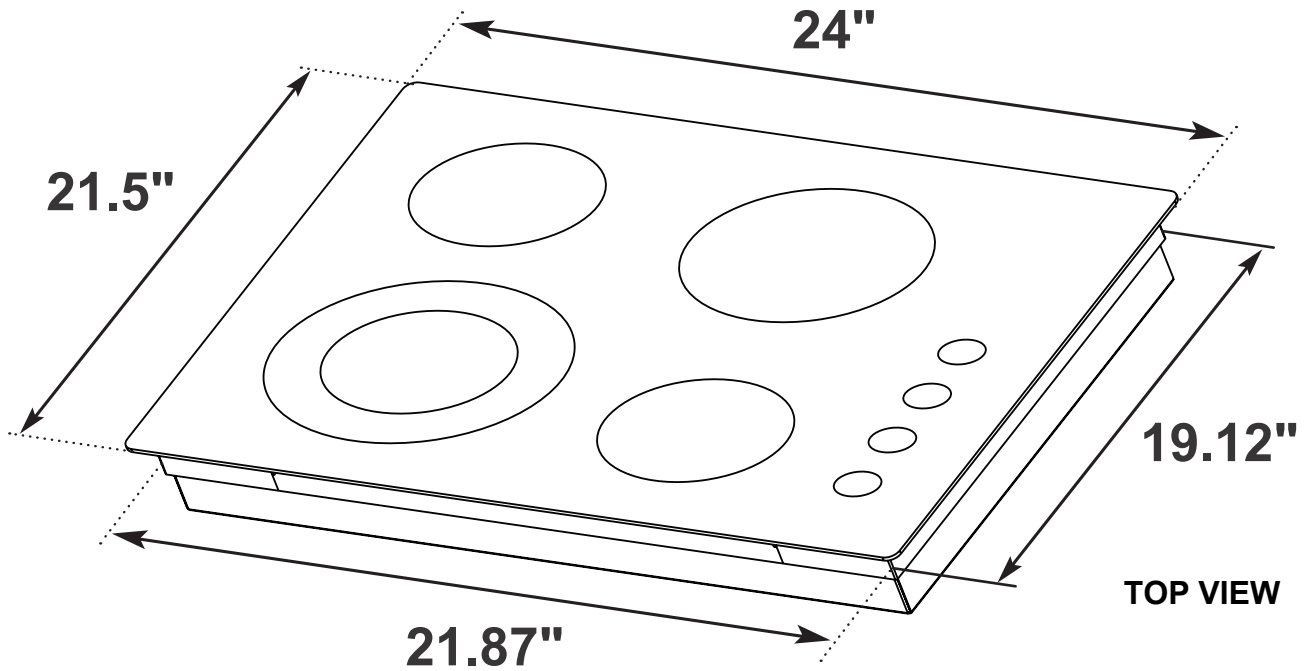

- A.)** Single Zone Burner: 5.9 in., 1200W
- B.)** Dual Zone Burner: 9.3 / 5.5 in., 2500W / 1200W
- C.)** Single Zone Burner: 7.5 in., 1800W
- D.)** Single Zone Burner: 5.9 in., 1200W
- E.)** Hot Surface Indicator Light
- F.)** Control Knobs

Weight: 20 lbs.

Voltage: 240V / 60Hz

Power Rating: 5500W

PRODUCT DIAGRAM: COS-304ECC

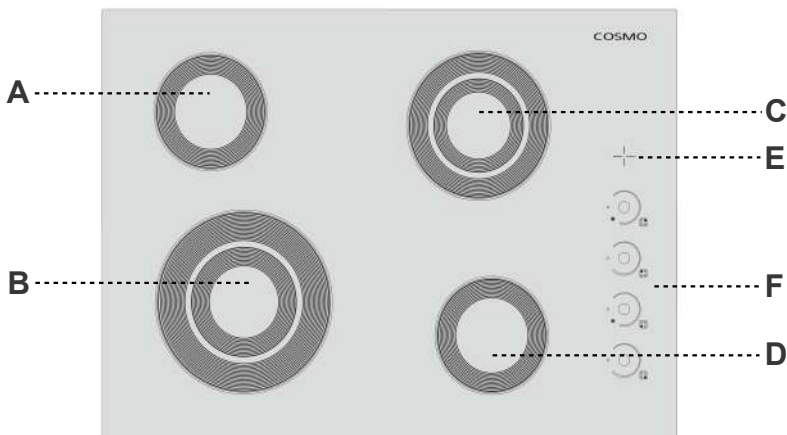
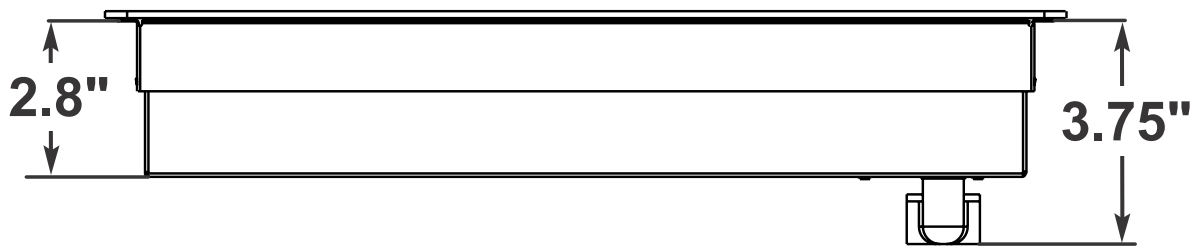
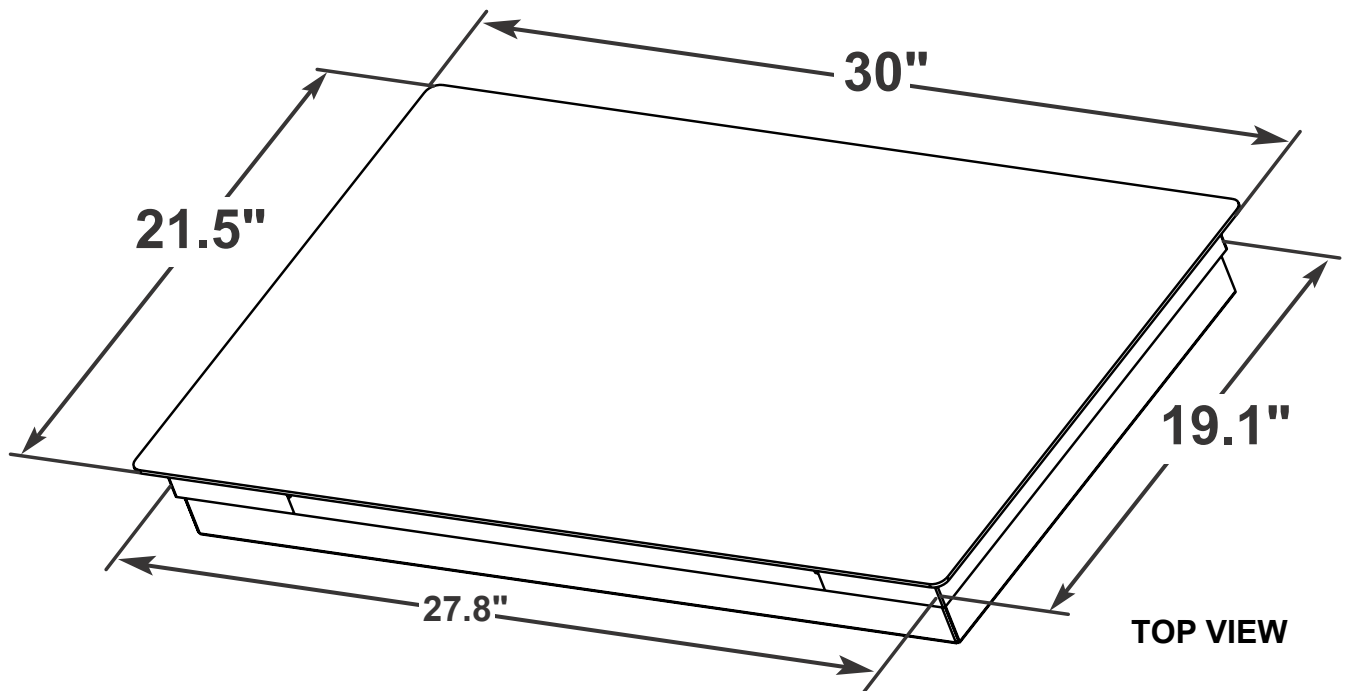

- A.)** Single Zone Burner: 5.9 in., 1200W
- B.)** Dual Zone Burner: 9.3 / 5.5 in., 2500W / 1200W
- C.)** Dual Zone Burner: 7.5 / 4.7, 1800W / 750W
- D.)** Single Zone Burner: 5.9 in., 1200W
- E.)** Hot Surface Indicator Light
- F.)** Control Knobs

Weight: 23.59 lbs.
Voltage: 240V / 60Hz
Power Rating: 6700W

PRODUCT DIAGRAM: COS-365ECC

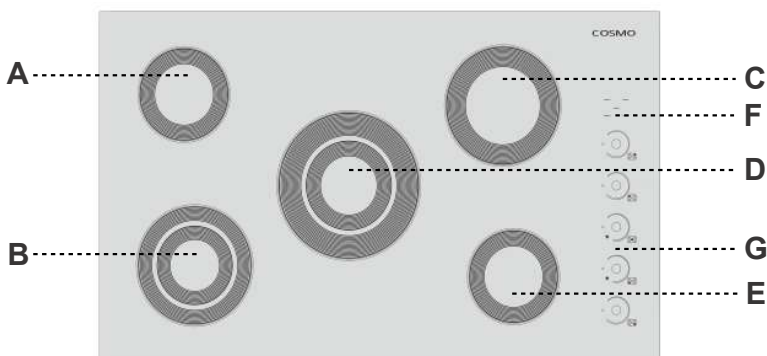
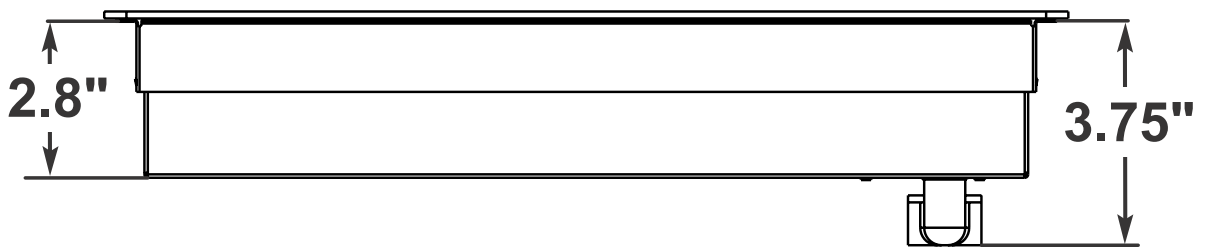
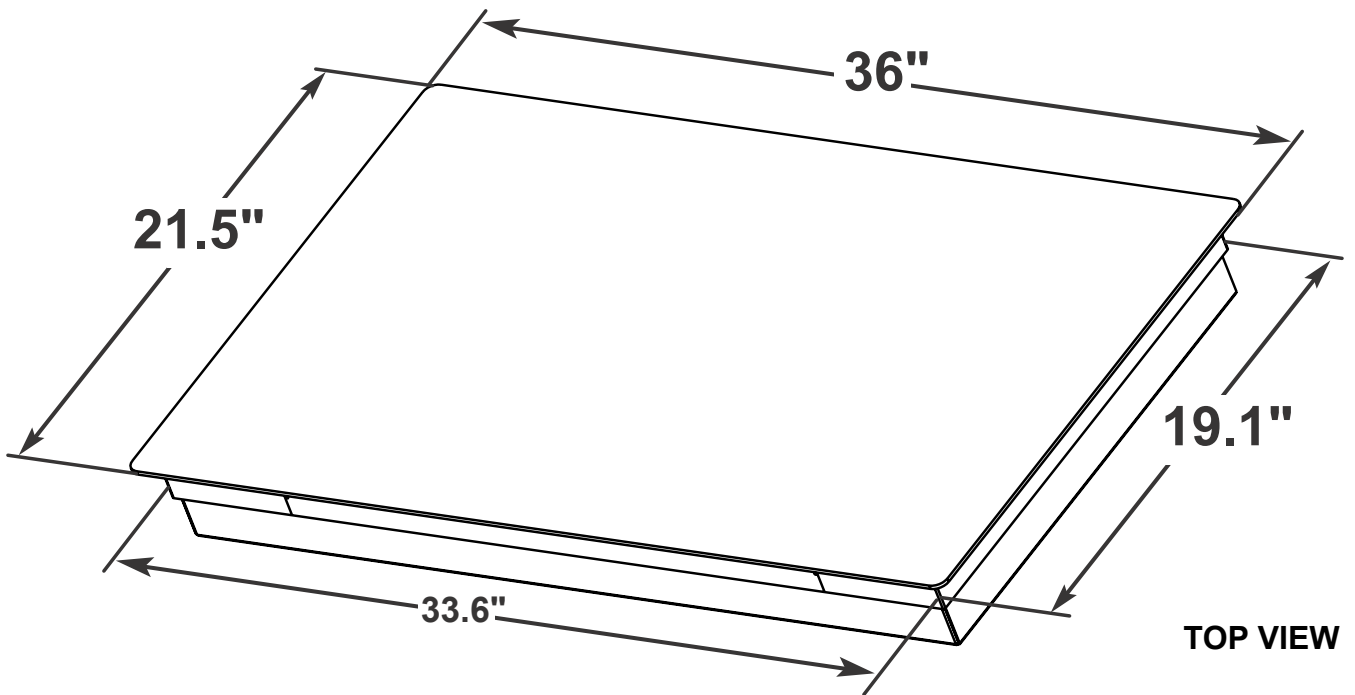

- A.)** Single Zone Burner: 5.9 in., 1200W
- B.)** Dual Zone Burner: 7.5 / 4.7 in., 1800W / 750W
- C.)** Single Zone Burner: 7.5 in., 1800W
- D.)** Dual Zone Burner: 9.3 / 5.5 in., 2500W / 1200W
- E.)** Single Zone Burner: 5.9 in., 1200W
- F.)** Hot Surface Indicator Light
- G.)** Control Knobs

Weight: 23.59 lbs.

Voltage: 240V / 60Hz

Power Rating: 6700W

TROUBLESHOOTING

PROBLEM	POSSIBLE CAUSE	SOLUTION
<p>Cooktop will not operate</p>	<p>a.) A household fuse blown, or a circuit breaker tripped.</p> <p>b.) Cooktop not wired properly.</p> <p>c.) Control knobs are not set correctly.</p>	<p>a.) Replace the fuse or reset the circuit breaker. If the problem continues, call an electrician.</p> <p>b.) Refer to “Installation Instructions” in the Cooktop Installation Manual.</p> <p>c.) Push in knob before turning to a setting.</p>
<p>Excessive heat around the cookware on cooktop</p>	<p>Cookware is not the proper size.</p>	<p>Use cookware about the same size as the surface cooking area, element or surface burner. Cookware SHOULD NOT extend more than 1/2” (1.3 cm) outside the cooking area, see Page 9.</p>
<p>Cooktop cooking results not what expected</p>	<p>a.) Is the proper cookware being used?</p> <p>b.) Is the control knob set to the proper heat level?</p> <p>c.) Is the cooktop level?</p>	<p>a.) Refer to “Cookware” section, Page 10.</p> <p>b.) Refer to “Cooktop Controls” section Page 7.</p> <p>c.) Level the cooktop. Refer to Installation Manual, Page 12, “Prepare Cooktop for Installation”.</p>
<p>A vapor is being emitted from the knobs of the cooktop</p>	<p>Is the cooktop in its first use(s)?</p>	<p>During the first use(s), a vapor may be seen exiting the holes around the knobs of the cooktop. This is normal and SHOULD disappear after use.</p>

WARRANTY AND SERVICE

For full warranty details on this product please visit:
<http://www.cosmoappliances.com/warranty>

TO RECEIVE WARRANTY SERVICE, YOUR
PRODUCT MUST BE REGISTERED. TO REGISTER, VISIT:

WWW.COSMOAPPLIANCES.COM/WARRANTY

SCAN TO REGISTER



IMPORTANT

Do Not Return This Product To The Store If
you have a problem with this product, please contact

Cosmo Customer Support at

+1(888)784-3108

DATED PROOF OF PURCHASE, MODEL #, AND SERIAL #

REQUIRED FOR WARRANTY SERVICE

IMPORTANT

Ne pas Réexpédier ce Produit au Magasin

Pour tout problème concernant ce produit, veuillez contacter

le service des consommateurs Cosmo Customer Support au

+1(888) 784-3108

UNE PREUVE D'ACHAT DATEE EST REQUISE POUR BENEFICIER DE

LA GARANTIE.

IMPORTANTE

No regrese este producto a la tienda

Si tiene algún problema con este producto, por favor contacte el

AYUDA AL CLIENTE COSMO al

+1(888)784-3108

(Válido solo en E.U.A).

NECESITA UNA PRUEBA DE DE COMPRA FECHADA, NÚMERO DE

MODELO Y DE SERIE PARA EL SERVICIO DE LA GARANTÍA

Correct Disposal of this product:



This marking indicates that this appliance should not be disposed with other household wastes. To prevent possible harm to the environment or human health from uncontrolled waste disposal, recycle it responsibly to promote the sustainable reuse of material resources.



APPLIANCES

Cosmo is constantly making efforts to improve the quality and performance of our products, so we may make changes to our appliances without updating this manual.

Electronic version of this manual is available at:
www.cosmoappliances.com