

SAFAVIEH C O U T U R E

Assembly Instruction

CAUTION: Read instruction carefully and turn electricity off at main circuit breaker panel before beginning installation.

ITEM#:CTL1015A

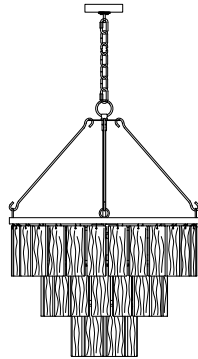

Care and Cleaning











To clean the outside of the fixture, use a dry or slightly dampened clean cloth (use clean water, never a solvent) to wipe the surface of the fixture.

To clear the inside of the fixture, first disconnect power to the fixture by turning off the circuit breaker or by removing the fuse at the fuse box. Next, use a dry or slightly dampened clean cloth (use clean water, never a solvent) to wipe the interior surface of the fixture.

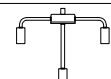
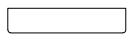
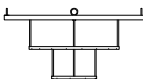
Do not use any cleaners with chemical, solvents or harsh abrasives. Use Only a dry soft cloth to dust or wipe carefully.

Estimated Assembly Time: 30 minutes

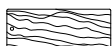
Part List and Hardware List

PIECE	DESCRIPTION	PICTURE	QUANTITY	PIECE	DESCRIPTION	PICTURE	QUANTITY
A	Mounting Plate		1X	H	Fixture Loop		1X
B	Wire Connector		3X	I	Iron Line Hook		4X
C	Mounting Screw		2X	J	Internal Lamp Frame		1X
D	Canopy		1X	K	Light Body		1X
E	Hanging Loop		1X	L	Bulb		5X
F	Canopy Nut		1X	M	Clear Glass		54X
G	Chain		1X				
G1	Closable Link		2X				

Instruction

Step 1

Unpack all parts from cartons carefully.

Place the Canopy(D) onto the Hanging Loop(E)

Place the tube of Mounting Plate(A) into the threaded portion of the Hanging Loop(E) and fix it by turning the Canopy Nut(F) clockwise till tight.

Attach the Closable Link(G1) onto the Hanging Loop(E)

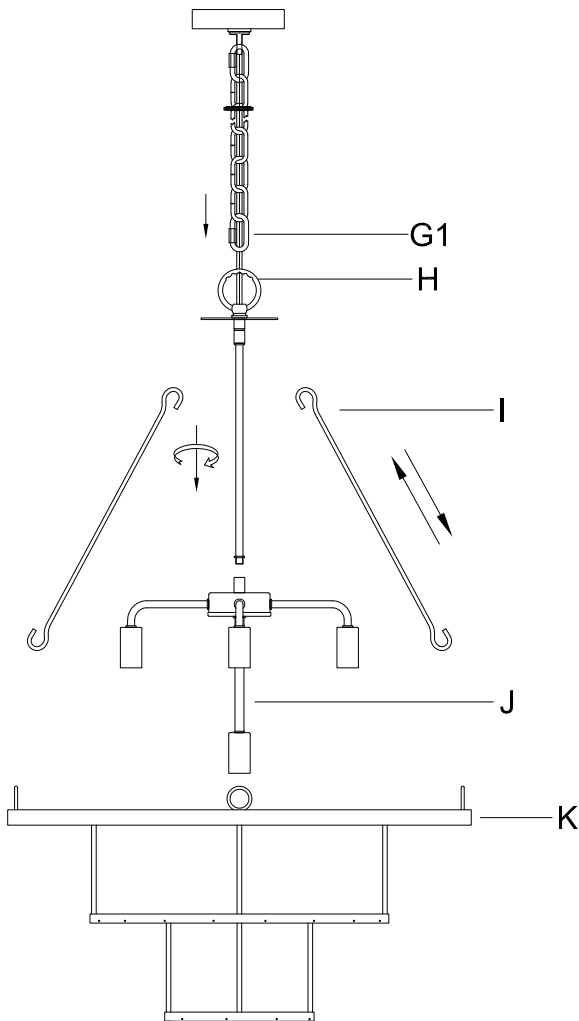
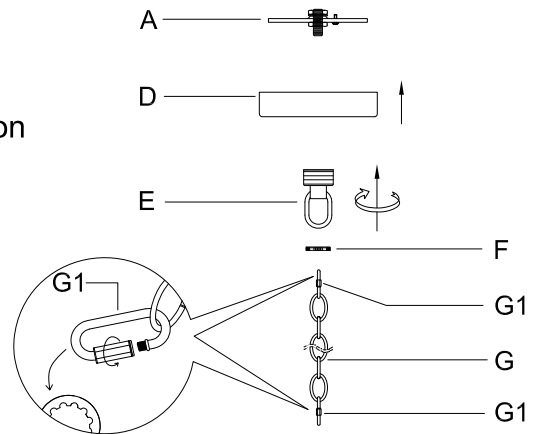

Step 2

Put ring (H) was twisted into the light frame (J) and then the iron hook (I) was attached to the ring (H), lamp body (K).

Put the closable link(G1) onto the fixture loop(H).

Step 3 Wire connection

Connect,Hot,Black or Red outlet Supply Wire to:	Connect,Neutral,White Outlet Supply Wire to:
Black	White
*Parallel Cord(round&smooth)	*Parallel Cord(square&ridged)
Clear,Brown,Gold or Black without Tracer(colored stripes)	Clear,Brwn,Gold or Black without Tracer(colored stripes)
Insulated Wire(not green)with copper metal conductor	Insulated Wire(not green)with Silver metal conductor

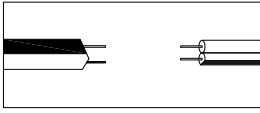

*Note: When parallel wire(SPTI&SPTII)is used. The neutral wire is square shaped and ridged and the hot wire will be round in shape and smooth.(See illustration on left)

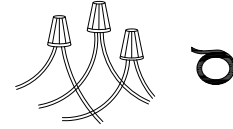

Grounding Instructions:

a) For installation in the United States: Wrap ground wire from outlet box around green ground screw on mounting bracket, no less than 2" from wire end. Tighten ground screw. If fixture is supplied with a ground wire, connect to outlet ground wire with a wire connector.

b) For installation in Canada: If fixture is supplied with ground wire, wrap ground wire around green grounding screw on mounting bracket. Tighten ground screw.

Step 4

Separate the Mounting Plate(A) from the Canopy(D) by turning the Canopy Nut(F) anti-clockwise.

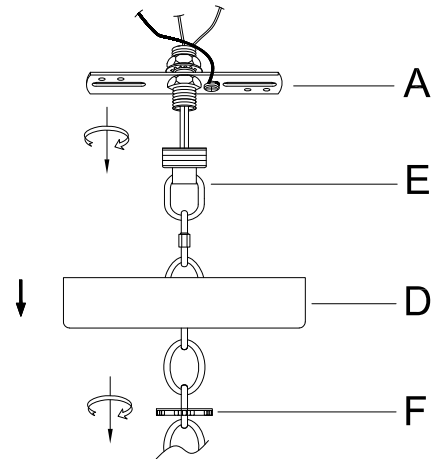

Step 5

Install the Mounting Plate(A) to the junction box with Mounting Screw (C)

Attach the Canopy(D) to the junction box and fix it by turning the Canopy Nut(F) clockwise

Insert the light bulb (L) into the inner lamp holder (J)
Insert the clear glass (K) on the lamp body (I).

**PLEASE USE ON/OFF TYPE "B" BULB MAX 40-WATT OR CFL BULB MAX 13-WATT OR LED BULB MAX 9-WATT
THERE IS LED 4-WATT BULB IN THE BOX**

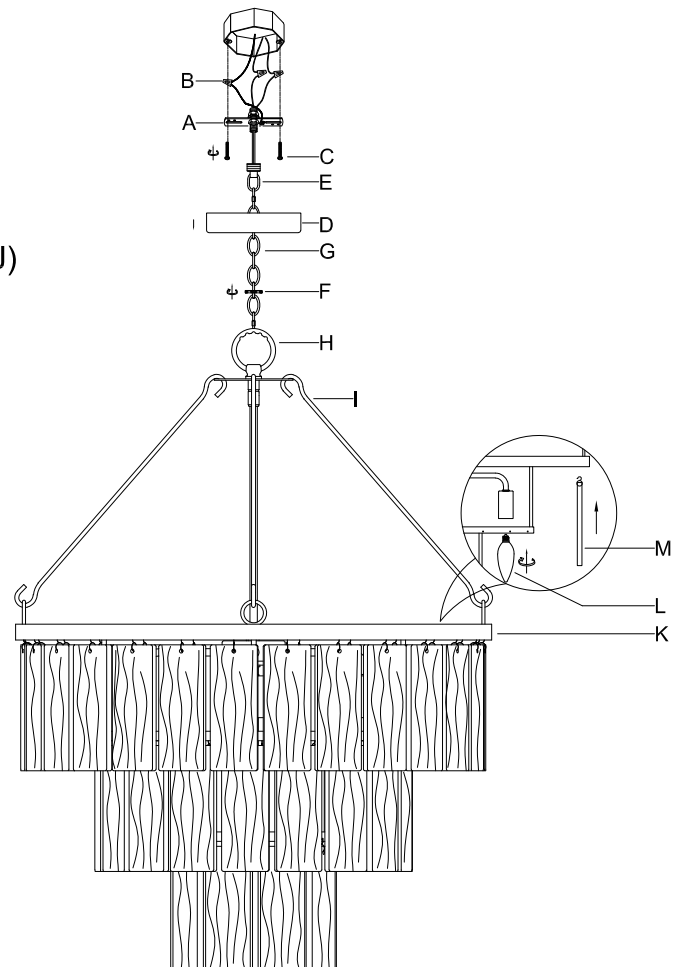

Step 6

Consult a qualified electrician to ensure correct branch circuit conductor.

ENJOY YOUR LAMP