

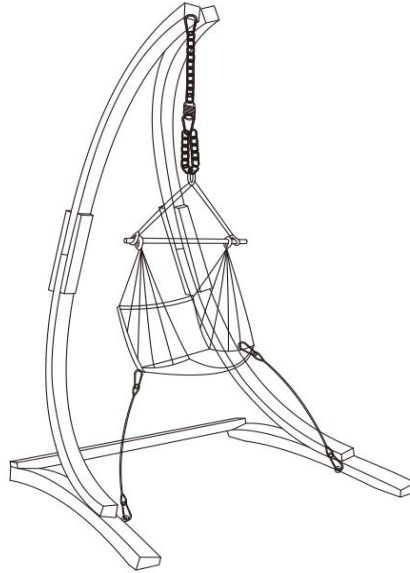









# Assembly Instructions

**Caution : You must read this before you proceed**

## **HAMMOCK CHAIR**

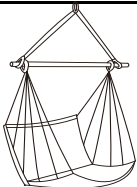

### Parts List

<b>Label</b>	<b>Picture</b>	<b>Description</b>	<b>QTY</b>
A		Leg Stop	1
B		Left Top Support	1
C		Right Top Support	1
D		Left Bottom Support	1
E		Right Bottom Support	1
F		Left Leg	1
G		Right Leg	1
H		Connection	4
I		Hammock Chair	1
J		Safty Fit(650mm)	2

# Hardware

Label	Picture	Description	QTY
①		Bolt (M10*150mm)	1
②		Bolt (M10*140mm)	8
③		Bolt (M10*130mm)	2
④		Bolt (M10*100mm)	2
⑤		Wrench	2
⑥		Handle	2
⑦		Hook(M8*60mm)	2
⑧		Nut	19
⑨		Washer	36
⑩		Spring	1
⑪		Chain (200mm)	2
⑫		Eye Bolt (M10*90mm)	2
⑬		Bolt (M10*120mm)	4

## Assembly Preparation

Before Beginning Assembly:

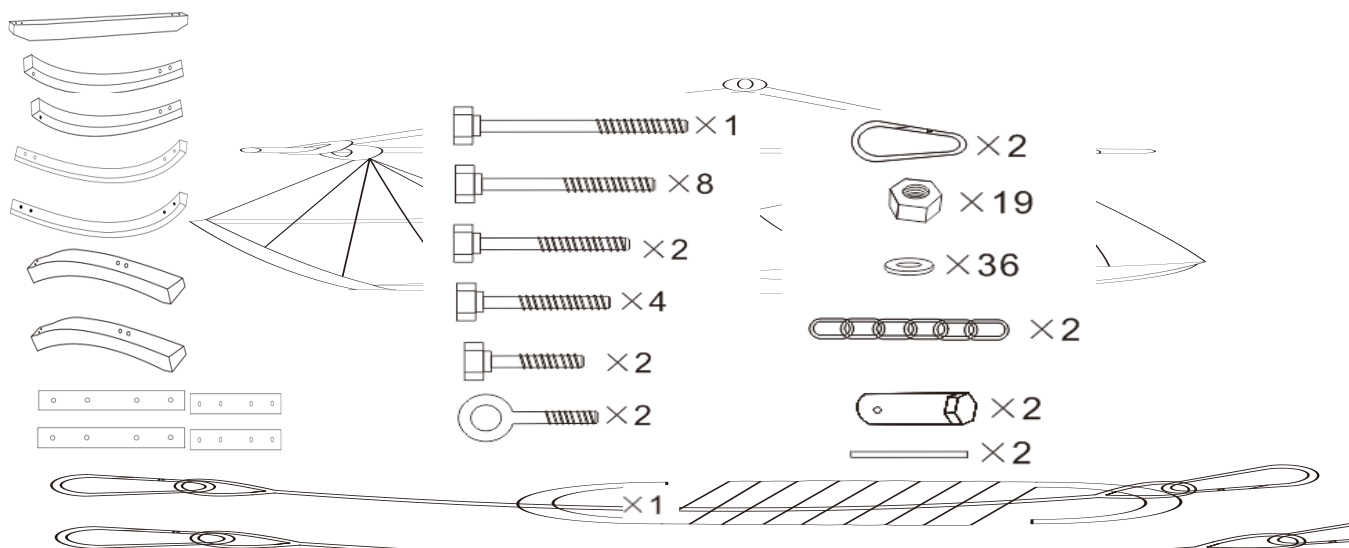



- Read instructions, cover to cover-



- Have 2 adults on hand for assembly-



- Do not assemble on flooring or carpet-



- Assemble on a clean non-marring surface (packing foam)-



- Save all packaging until finished-

## Overview

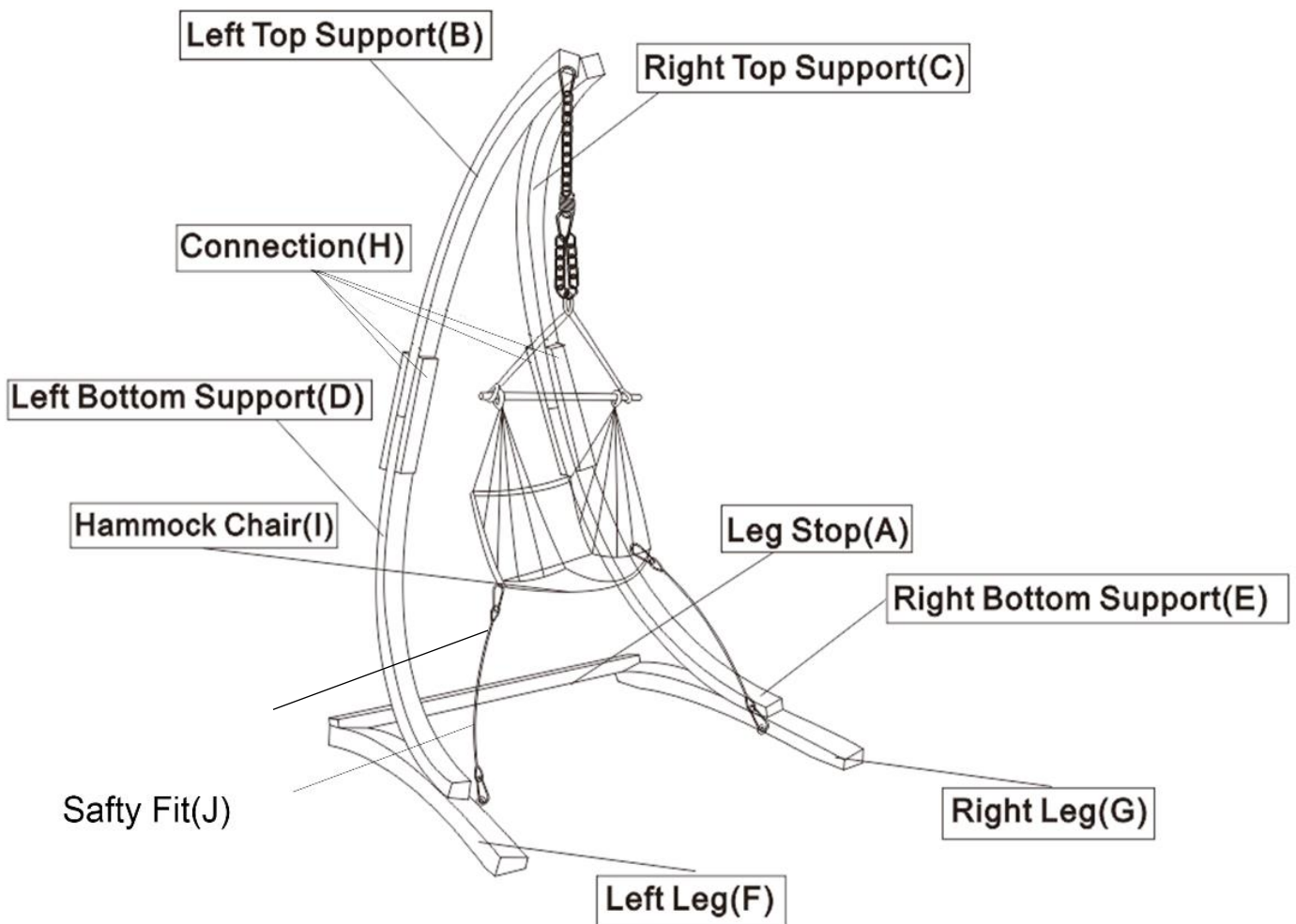

# Assembly Steps

## Step 1

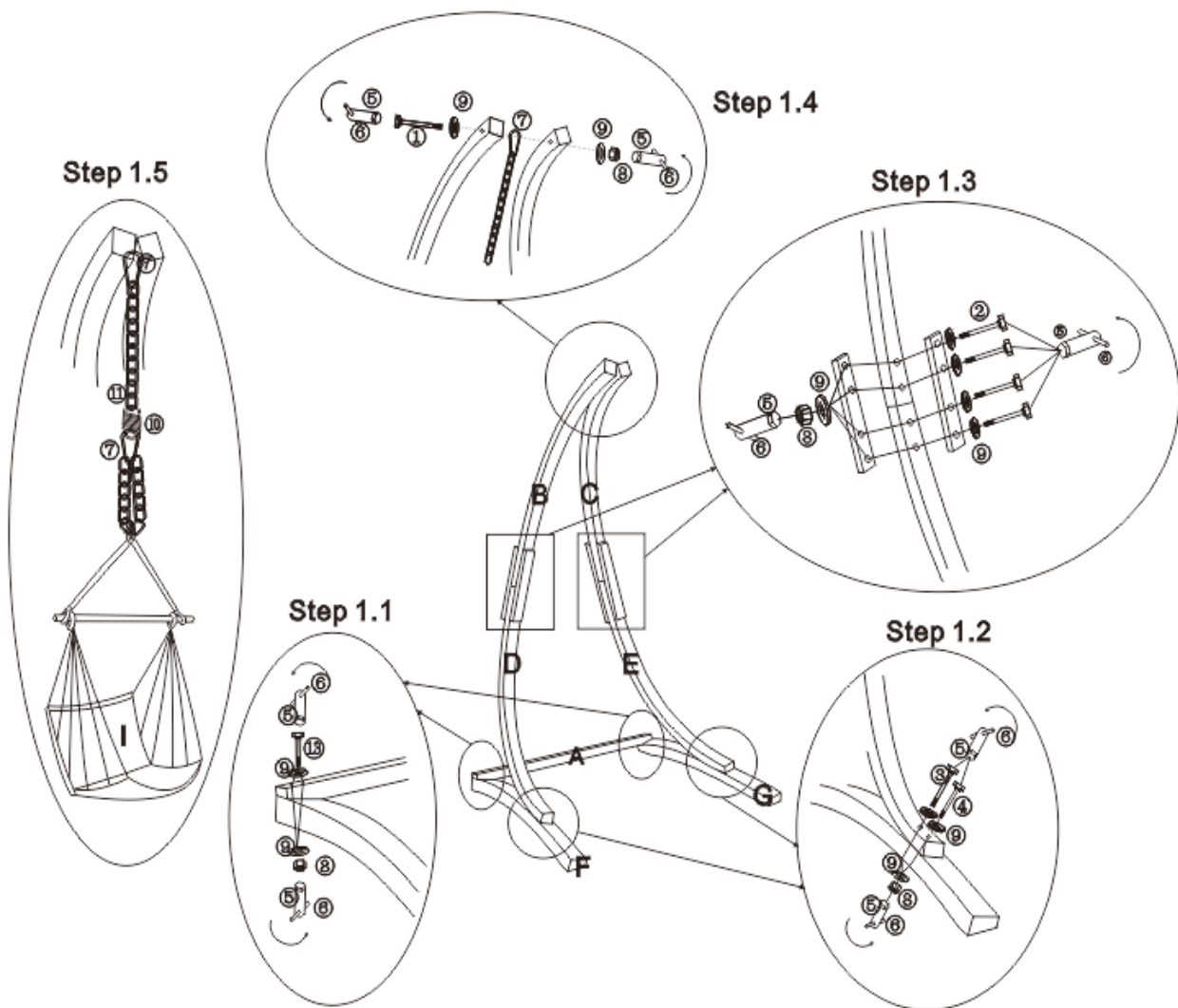

**1.1)** Attach Leg Stop(A) to Left Leg(F) and Right Leg(G), using Bolts(13), Nuts(8), and Washers(9) with Wrenches(5) and Handles(6).

**1.2)** Attach Left Bottom Support(D) to Left Leg(F) and Right Bottom Support(E) to Right Leg(G), using Bolts(4), Bolts(3), Washers(9), and Nuts(8) with Wrenches(5) and Handles(6) as pictured above.

**1.3)** Attach Connections(H) to both sides of Left Top Support(B), and Left Bottom Support(D), and Right Top Support(C) and Right Bottom Support(E), using Bolts(2), Washers(9), and Nuts(8) with Wrenches(5) and Handles(6) as pictured.

**1.4)** Attach Hook(7) between Left Top Support(B), and Right Top Support(C) using Bolt(1), Washers(9), and Nut(8) with Wrenches(5) and Handles(6) as shown. Attach Chain(11) and Spring(10) to Hook(7).

**1.5)** Attach Hammock Chair(I) to Wooden Stand with Chain(11) Hook(7) and Spring(10).

**Fully tighten all Bolts and Nuts in a sequential manner.**

## Step 2

### Step 2.1

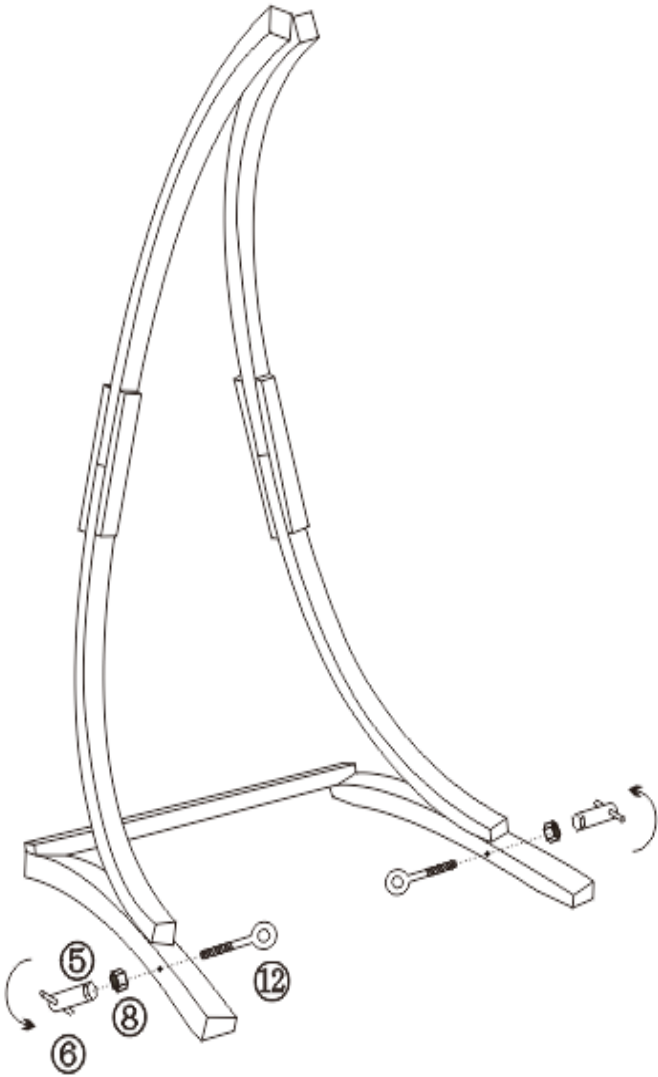

### Step 2.2

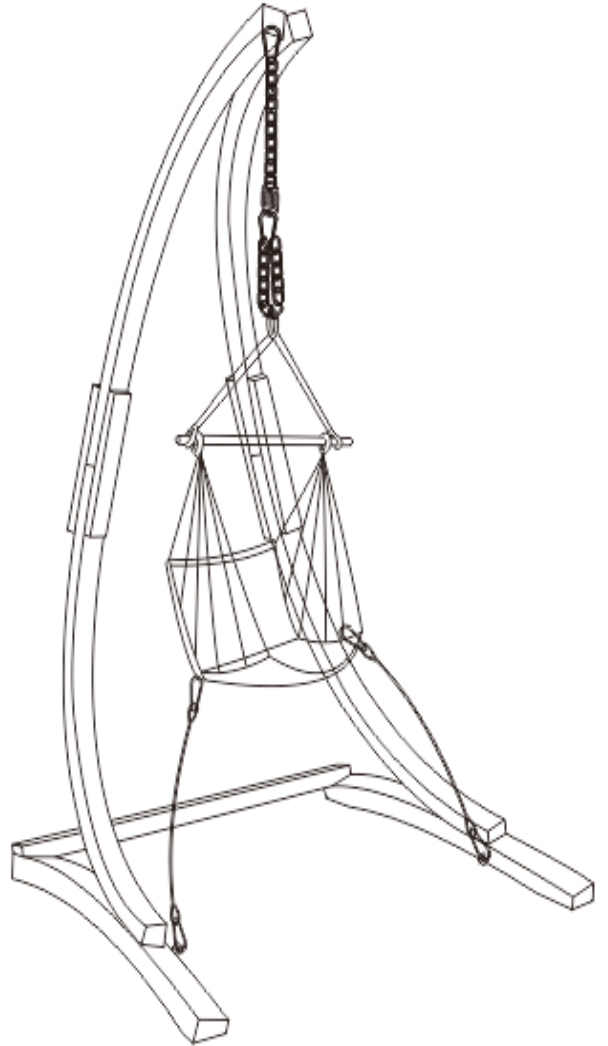

**2.1)** Install Eye Bolts(12) and Nuts(8) to Left Leg(F) and Right Leg(G) with Wrenches(5) and Handles(6).

**2.2)** Attach Hammock Chair(I) to Left Leg(F) and Right Leg(G), using Safety Lines(J).

## Step 3

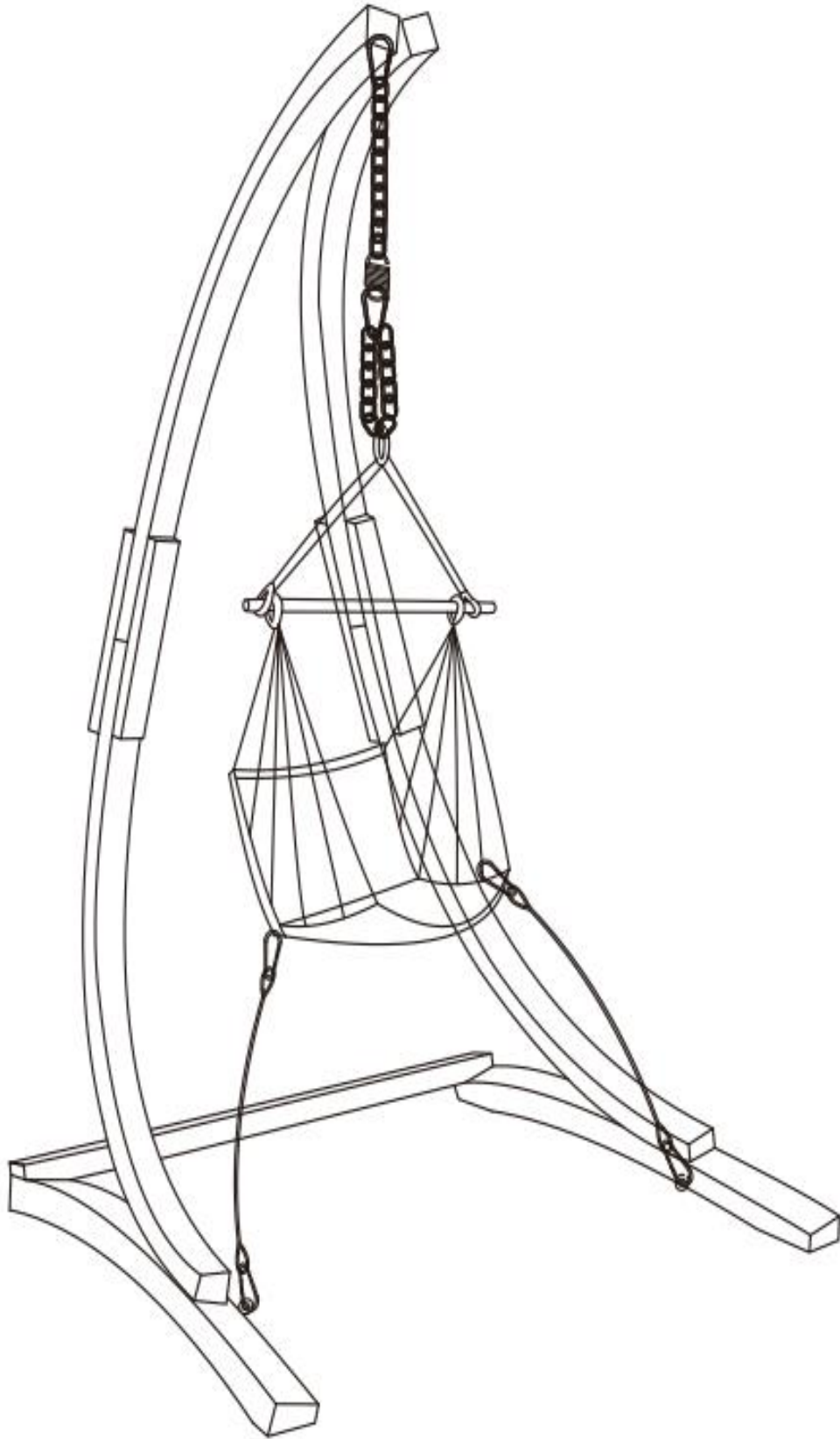

Your Wooden Stand with Hammock Chair is ready for use.

**This Wooden Stand with Hammock Chair can only be used on a flat, level surface.**

**Please be careful when getting on and off the Hammock Chair.**

**Children must be supervised at all times when using the Hammock Chair.**

## Care & Maintenance

-   ● Do not put hot items directly on furniture surface.
  -   ● Do not clean furniture with harsh cleansers or polish.
  -   ● To obtain the longest lifespan of your outdoor products, minimizing exposure to direct sunlight is recommended.
  -   ● Children should not climb or jump on the furniture.
  -   ● Do not write on furniture without a padded barrier to protect the surface.
  -   ● To obtain the longest lifespan of your outdoor products, avoid extended and lengthy exposure to rain, snow, and direct sunshine. Whenever possible cover the product and /or place under patio or awnings.
  -   ● Not for commercial use. For residential use only.
  -   ● Stains may be removed with mild soap solution and damp cloth.
- 
-   ● Dust and pick-up spills using a clean, non-colored, lint-free cloth.

### Questions & Answers about Proposition 65

#### • What is Proposition 65?

Proposition 65 requires businesses to provide warnings to Californians about significant exposures to chemicals that cause cancer, birth defects or other reproductive harm. These chemicals can be in the products that Californians purchase, in their homes or workplaces, or that are released into the environment. By requiring that this information be provided, Proposition 65 enables Californians to make informed decisions about their exposures to these chemicals.

Proposition 65 also prohibits California businesses from knowingly discharging significant amounts of listed chemicals into sources of drinking water.

Proposition 65 requires California to publish a list of chemicals known to cause cancer, birth defects or other reproductive harm. This list, which must be updated at least once a year, has grown to include approximately 900 chemicals since it was first published in 1987.

#### • What types of chemicals are on the Proposition 65 list?

The list contains a wide range of naturally occurring and synthetic chemicals that include additives or ingredients in pesticides, common household products, food, drugs, dyes, or solvents. Listed chemicals may also be used in manufacturing and construction, or they may be byproducts of chemical processes, such as motor vehicle exhaust.

#### • What does a warning mean?

If a warning is placed on a product label or posted or distributed at a workplace, a business, or in rental housing, the business issuing the warning is aware or believes that it is exposing individuals to one or more listed chemicals.

By law, a warning must be given for listed chemicals unless the exposure is low enough to pose no significant risk of cancer or is significantly below levels observed to cause birth defects or other reproductive harm.

#### • Where can I get more information on Proposition 65?

If you have specific questions on the administration or implementation of Proposition 65, you can contact OEHHA's Proposition 65 program at [P65.Questions@oehha.ca.gov](mailto:P65.Questions@oehha.ca.gov), or by phone at (916) 445-6900.